

T
2
0
1
1



LUCIFERO[®]
ILLUMINAZIONE

The Vision - 2011

La paura alberga nell'anima di ogni essere umano, la paura del buio, la paura dell'ignoto, la paura per il futuro.

Nel nuovo catalogo Lucifero, anche i luoghi abbandonati e fatiscenti, come fabbriche ormai cadute in rovina, prendono nuova vita, nel silenzio della solitudine.

Abbandonandosi tra le mura del passato, l'uomo e la donna sconfiggono la decadenza del lento scorrere del tempo, riscoprendo il colore e la bellezza della vita attraverso la luce.

“Perché la luce sia splendente, ci deve essere l'oscurità”.
(Francesco Bacone)

La “luce” carica di tutti i suoi significati simbolici intrinseci diventa nuovamente protagonista, unica nel suo genere, compagna di vita della nostra quotidianità.

La Luce diventa estemporanea, slegata dal concetto spazio tempo e non si potrà più parlare di un ieri, di un oggi e di un domani senza che un po' di “luce” gli doni un nuovo e rinnovato splendore.

La peur habite dans l'ame de chaque etre humaine, la peur de l'obscurité, la peur de l'inconnu, la peur de l'avenir.

Les lieux depuis longtemps abandonnés or croulants comme les vieux moulins or usines prennent une nouvelle vie, dans le silence de la solitude.

L'homme et la femme, qui errent entre ces murs du passé, vaincrent la décadence du lente passer du temps, en découvrant les couleurs et la beauté de la vie à travers la lumière.

D'après la citation de Francesco Bacone:
«La lumière devient brillante après l'obscurité».

La lumière avec tous ses significations symboliques et intrinsèques devient de nouveau protagoniste, unique dans son espèce, partenaire de vie pendant tous nos jours.

La lumière devient improvisée, détachée de l'idée space-temps et nous ne discuterons plus du passé, d'aujourd'hui et du futur sans que un peu de « lumière » leur ait donner un nouvel et renouvelé splendeur.

The fear is lodged in the soul of every human being, fear of darkness, fear of unknown, fear of the future.

In the very new catalogue of Lucifero's company, even the very old abandoned and crumbling places such as mills or factories have a new life in the great silence of solitude.

Man and woman, wandering among these walls dating from centuries, are defeating the decadence of the slow flowing of time and they are rediscovering shades and beauty of life through the light.

Francesco Bacone cited “ In order to have light shining, there must be darkness”

The “light” with all its figurative essential meanings has gained again a leading role, unique in its nature, a partner in our everyday's life.

The light is becoming extemporaneous, loose from the concept of space-time and so we will argue about past times, about nowadays' life or about the future with light giving a new and renewed brilliance on our life.

El miedo alberga en el alma de cada ser humano, el miedo de la oscuridad, el miedo de lo desconocido, el miedo del futuro.

En el nuevo catálogo Lucifero, incluso los lugares abandonados y en mal estado, como fábricas ya caídas en ruínas toman nueva vida en el silencio de la soledad.

Abandonándose entre los muros del pasado, el hombre y la mujer vencen la decadencia del lento discurrir del tiempo, volviendo a descubrir el color y la belleza de la vida a través de la luz.

“Para que la luz sea esplendente, es necesario que exista la oscuridad” (Francesco Bacone)

La “luz” cargada de todos sus significados simbólicos intrínsecos se vuelve protagonista, única en su género, compañera de vida en nuestra cotidianidad.

La luz se vuelve estemporanea, separada del concepto espacio tiempo y ya no se podrá hablar de un ayer, de un hoy y de un mañana sin que un poco de “luz” le dé un nuevo esplendor renovado.

Video THE VISION



Nel Catalogo 2011 - Lucifero Illuminazione s.r.l. introduce il sistema di codifica QR Code.

Tale simbolo consente di accedere alle informazioni multimediali ad esso collegate tramite uno Smart Phone attraverso un'applicazione di lettura dello stesso. L'applicazione si può scaricare gratuitamente da internet ed installare sul proprio apparecchio telefonico.

The Vision

Y 2 K 1 1

TAVOLO
TABLE

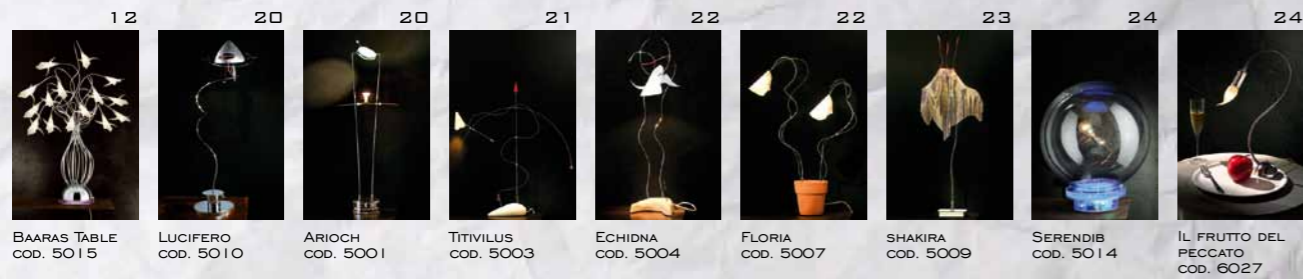

PARETE
WALL



TERRA
FLOOR



LEGENDA FINITURE:

- (CR) = Cromo
- (RA) = Rame
- (RUG) = Ruggine
- (VB) = Verniciatura Bianca
- (VG) = Verniciatura Grigia
- (VNM) = Verniciatura Nera Micacea
- (ZB) = Zincatura Bianca
- (ZG) = Zincatura Gialla

LEGENDA LED:

- [C] = Calda, Warm 3.000° K - 107 LUMEN x WATT
- [N] = Naturale, Natural 4.000° K - 114 LUMEN x WATT

LUCIFERO IS MADE IN ITALY

Lucifero Illuminazione S.r.l. è aderente al Consorzio ECOLIGHT.
Iscrizione al Registro A.E.E. n. IT0802000002910

SOSPENSIONE
SUSPENSION



FOLLIE
MADNESSES



GIARDINI
GARDENS

ANDROID
98 - 101



LED - NEURON PROJECT PAG. 108 - 117



LEGENDA LED:

- [C] = Calda, Warm 3.000° K - 107 LUMEN x WATT
- [N] = Naturale, Natural 4.000° K - 114 LUMEN x WATT

SISTEMA TOTAM PAG. 118 - 122
TOTAM SYSTEM PAG. 118 - 122



SISTEMA CAVI BASSA TENSIONE 12V PAG. 123 - 131
LOW VOLTAGE CABLE SYSTEM 12V PAG. 123 - 131



NOTA BENE:
Su tutti i nostri prodotti in bassa tensione 12V (con trasformatore elettronico, elettromeccanico o toroidale) non è consigliato l'uso di potenziometri o variatori. Si raccomanda inoltre su tutti i prodotti in bassa tensione 12V (es. testate, applique) di controllare periodicamente i punti di contatto ed eventualmente serrarli, col tempo la dilatazione termica può determinare un allentamento delle viti.

SISTEMA COLOMBO 220/240V PAG. 132 - 135
COLOMBO SYSTEM 220/240V PAG. 132 - 135

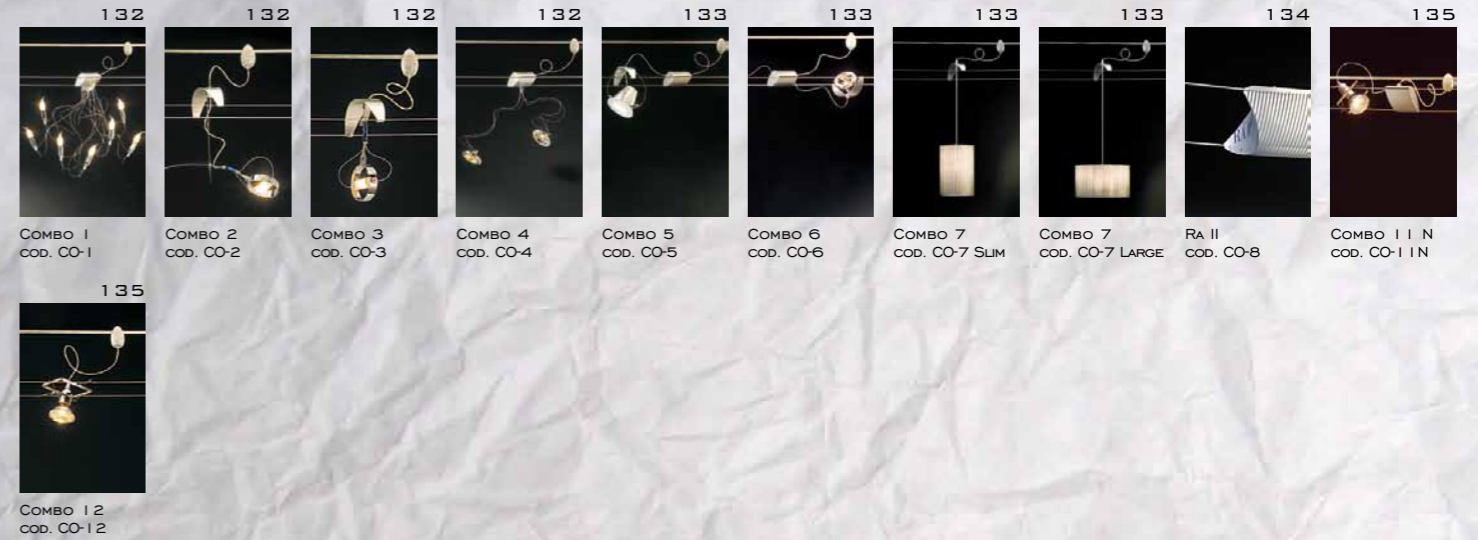

REPORTAGE
REPORTAGE



74 - 75



88 - 89



90 - 91



94 - 95



102 - 103



104 - 105



136 - 137



138 - 139



140 - 141



142 - 143



144 - 145



146 - 147



148 - 149



150 - 151



152



Casa Privata
Private House



Luci di Donne
Roma - Paliano - Napoli



Luci di Donne
Roma - Paliano - Napoli

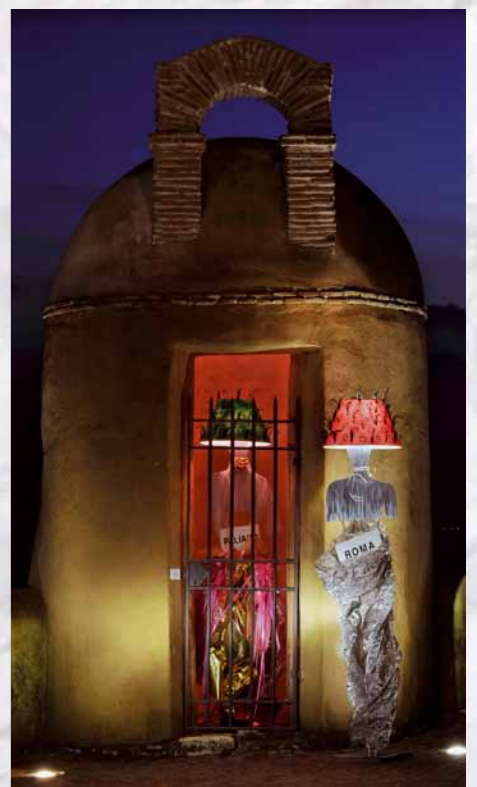



Video Showroom





SHOWROOM LUCIFERO ILLUMINAZIONE



SHOWROOM LUCIFERO ILLUMINAZIONE



Cod. 5015

B A A R A S T A B L E

15 x 20 W max G4 12V

LED SMD 2,4W 12V DC



Base: Rame Cromato
Steli: Rame Cromato
Lampadina: Dicroica \varnothing 35 mm
LED: SMD bianchi nella base 2,4W 12V DC
Traformatore: Toroidale 300W 230V 12V ed Alimentatore Elettronico inseriti nella base
Peso e misure con imballo: 9 Kg - 480 x 490 x 1.150 mm

Base: Chrome copper
Stem: Chrome copper
Bulb: 15 x 20W G4 12V
Led: White SMD in base
Transformer: Toroidal 300W 230V 12V and Feed supply in base
Weight and measurements including packaging: 9 Kg - 480 x 490 x 1.150 mm



Base: Cuivre Chromé
Tiges: Cuivre Chromé
Ampoules: 15x20W G4 12V
LED: SMD blancs dans la base
Transformateur: Toroidal 300W 230V 12V et Alimentation dans la base
Poids et mesures avec emballage: 9 Kg - 480 x 490 x 1.150 mm

Base: De Cobre Cromado
Tubos: Cobre Cromado
Bombillas: 15X20 W G4 12V
LED: SMD blancos en la base
Transformador: Toroidal 300W 230V 12V y Alimentador en la base
Peso y medidas con embalaje: 9 Kg - 480 x 490 x 1.150 mm

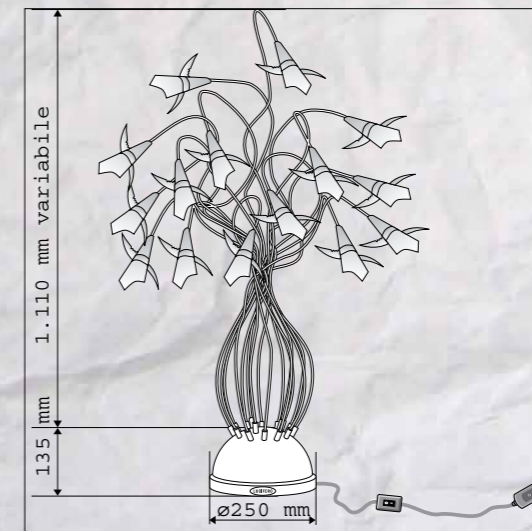

Cod. 7538 RUG

AVALON

4 x 75W max G53 230/12V



Base: Metallo
 Finitura: Ruggine Protetta
 Opzioni: Verniciato Grigio (VG), Nero Micaceo (VNM), Zincato Bianco (ZB), Zincato Giallo (ZG)
 Lampadina: Halospot
 Trasformatore: Toroidale 300W 230V 12V inserito nel cono
 Peso e misure con imballo: 5 Kg - 260 x 450 x 1.130 mm

Base: Metal
 Finish: Protected Rust
 Options: Grey Paint (VG), Black Micaceous (VNM), Galvanized White (ZB), Yellow (ZG)
 Bulb: Halospot
 Transformer: Toroidal 300W 230V 12V in cone
 Weight and measurements including packaging: 5 Kg - 260 x 450 x 1.130 mm

Cod. 7539/4 RUG

CAMELOT

4 x 70W max GX8,5 CDM R111 220-240V

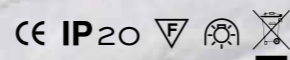

Base: Metallo
 Finitura: Ruggine Protetta
 Opzioni: Verniciato Grigio (VG), Nero Micaceo (VNM), Zincato Bianco (ZB), Zincato Giallo (ZG)
 Lampadina: Ioduri Metallici
 Alimentazione: nr. 4 Alimentatori Elettronici 220/240V 70W inseriti nella base
 Peso e misure con imballo: 8 Kg - 450 x 310 x 750 mm

Base: Metal
 Finish: Protected Rust
 Options: Grey Paint (VG), Black Micaceous (VNM), Galvanized White (ZB), Yellow (ZG)
 Bulb: Metal Iodide
 Feed Supply: no. 4 Electronic transformers: 220/240V 12V in base
 Weight and measurements including packaging: 8 Kg - 450 x 310 x 750 mm

**Cod. 7538 RUG****Cod. 7539/4 RUG**

Base: Métal
 Finition: Rouille Protégée
 Options: Verni Gris (VG), Noir Micacé (VNM), Zingage Blanc (ZB), Jaune (ZG)
 Ampoules: Halospot
 Transformateur: Toroidal 300W 230V 12V inséré dans le cône
 Poids et mesure avec emballage: 5 Kg - 260 x 450 x 1.130 mm

Base: Metal
 Acabado: Oxidado Protegido
 Opciones: Barnizado Gris (VG), Negro Micáceo (VNM), Galvanizado con Zinc en Blanco (ZB), Amarillo (ZG)
 Bombilla: Halospot
 Transformador: Toroidal 300W 230V 12V introducido en el cono
 Peso y medida con embalaje: 5 Kg - 260 x 450 x 1.130 mm

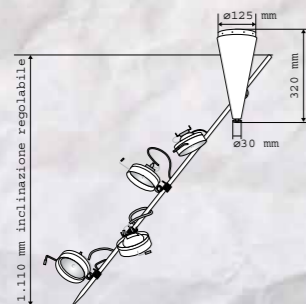

Base: Métal
 Finition: Rouille Protégée
 Options: Verni Gris (VG), Noir Micacé (VNM), Zingage Blanc (ZB), Jaune (ZG)
 Ampoules: Iodures Métalliques
 Alimentation: n° 4 Alimentations Electroniques 220/240V 70W insérées dans la base
 Poids et mesure avec emballage: 8 Kg - 450 x 310 x 750 mm

Base: Metal
 Acabado: Oxidado Protegido
 Opciones: Barnizado Gris (VG), Negro Micáceo (VNM), Galvanizado con Zinc en Blanco (ZB), Amarillo (ZG)
 Bombilla: Yoduro Metálicos
 Alimentación: n° 4 Alimentadores Electrónicos 220/240V 70W introducidos en la base
 Peso y medidas con embalaje: 8 Kg - 450 x 310 x 750 mm

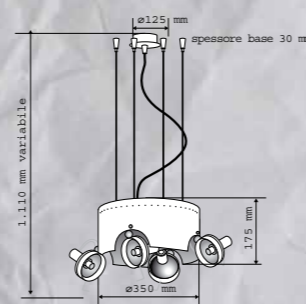
**Cod. 7541/4 RUG Plafone**

Cod. 7537 Black
Cod. 7536 White
LUCEM FERENS (Sosp)

1 x 23W E 27 FBT 230V

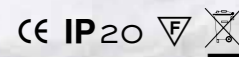

Base: Rame
 Finitura: Cromo (CR)
 Paralume: Nero serigrafato
 Opzione: Bianco
 Lampadina: Risparmio Energetico
 Peso e misure con imballo: 2 Kg (800 x 800 x 520 mm)

Base: Copper
 Finish: Chrome (CR)
 Shade: Black silk-screen printed
 Option: White
 Bulb: Energy Saving
 Weight and measurements including packaging: 2 Kg (800 x 800 x 520 mm)



Cod. 7017 White
Cod. 7018 Black
LUCEM FERENS

1 x 23W E 27 FBT 230V

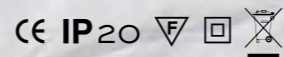

Base: Metallo spazzolato cromato
 Stelo: Metallo cromato
 Paralume: Bianco serigrafato
 Opzione: Nero
 Lampadina: Risparmio Energetico
 Peso e misure con imballo: 10 Kg [(360 x 470 x 2.150 mm) + (800 x 800 x 520 mm)]

Base: Brushed metal chrome
 Stem: Chrome metal
 Shade: White silk-screen printed
 Option: Black
 Bulb: Energy Saving
 Weight and measurements including packaging:
 10 Kg [(360 x 470 x 2.150 mm) + (800 x 800 x 520 mm)]

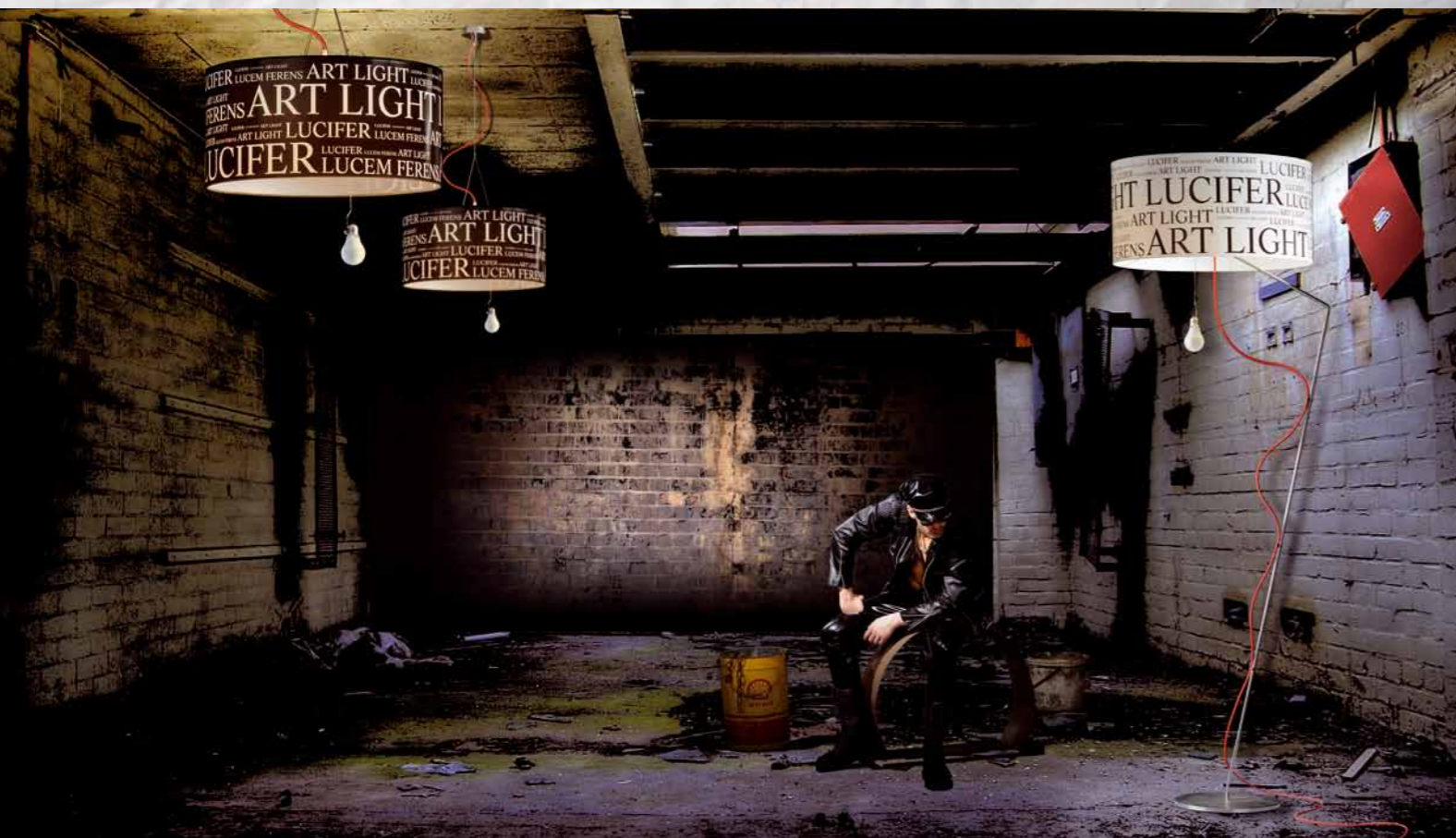

Cod. 7536 White

Video Lucem Ferens



Base: Cuivre
 Finition: Chrome (CR)
 Abat-jour: Noir sérigraphié
 Option: Blanc
 Ampoule: 1x23W E 27 FBT 230V
 Poids et mesures avec emballage: 2 Kg [(800 x 800 x 520 mm)]

Base: Cobre
 Acabado: Cromo (CR)
 Pantalla: Negro serigrafado
 Opción: Blanco
 Bombilla: 1x23W E 27 FBT 230V
 Peso y medidas con embalaje: 2 Kg (800 x 800 x 520 mm)

Base: Métal brossé chromé
 Tige: Métal chromé
 Abat-jour: Blanc sérigraphié
 Option: Noir
 Ampoule: 1x23W E 27 FBT 230V
 Poids et mesures avec emballage:
 10 Kg [(360 x 470 x 2.150 mm) + (800 x 800 x 520 mm)]

Base: Metal cepillado cromado
 Tubo: Metal cromado
 Pantalla: Blanco serigrafado
 Opción: Negro
 Bombilla: 1x23W E 27 FBT 230V
 Peso y medidas con embalaje:
 10 Kg [(360 x 470 x 2.150 mm) + (800 x 800 x 520 mm)]

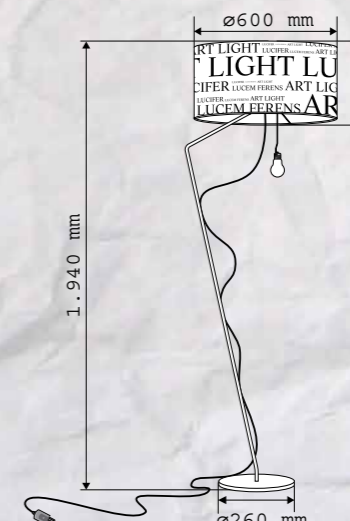
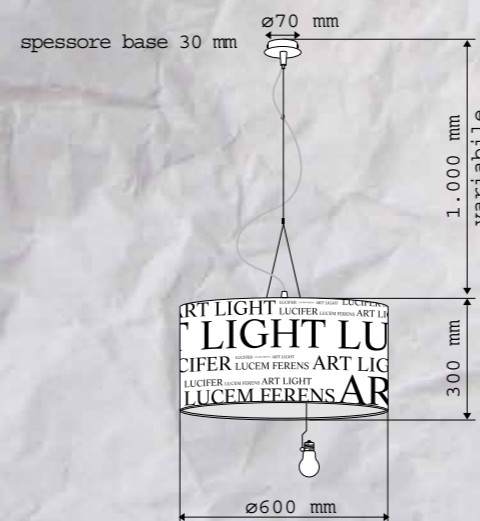

Cod. 7018 Black

Cod. 6050 OTT
Cod. 6050 CR

C A X
2 x 50W max 230V GU10
LED SMD 1,4W 12V



Figura: In ottone rivestita in silicone nero
Opzione: Cromata
Particolarità: Silicone Nero e Tessuto Metallico
Lampadina: Alogena
LED SMD: rosso 1,4W 12V nella base dietro la figura
Driver: inserito nella base
Peso e misure con imballo: 2 Kg (450 x 260 x 1.130 mm)

Figure: Brass covered in black silicone
Option: Chrome
Details: Black Silicon and Fabric Metal
Bulb: Halogen
LED: Red SMD 1,4W 12V in base behind the figure
Driver: within the base
Weight and measurements including packaging: 2 Kg (450 x 260 x 1.130 mm)



Cod. 6050 CR

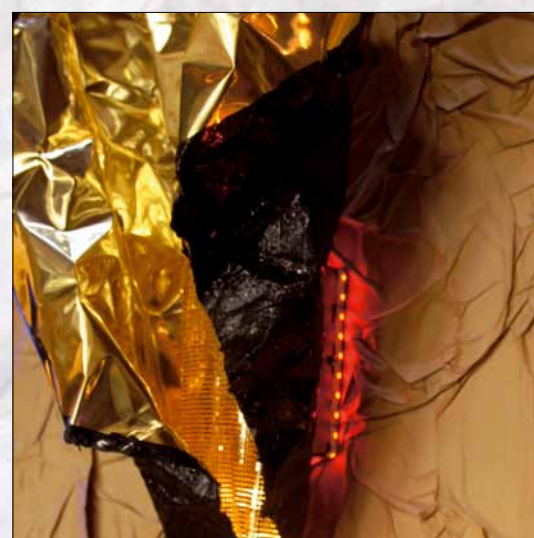
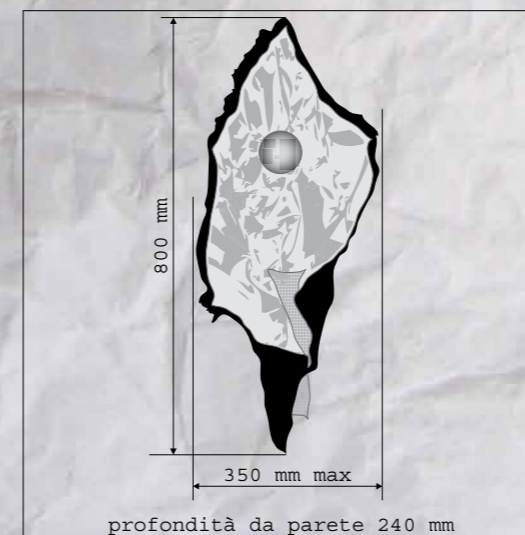

Figure: En laiton revêtue de silicone noire
Option: Chromée
Peculiarité: Silicone Noir et Tissu Métallique
Ampoules: Alogéne
Led: SMD rouge 1,4W 12V dans la base derrière la figure
Driver: inséré dan la base
Poids et mesures avec emballage: 2 Kg (450 x 260 x 1.130 mm)

Figura: De latón recubierta con silicona negra
Opción: Cromada
Particularidades: Negro y silicio metálico tela
Bombillas: Halógena
Led: SMD rojo 1,4W 12V en la base detrás de la figura
Driver: incluidos en la base
Peso y medidas con embalaje: 2 Kg (450 x 260 x 1.130 mm)





Cod. 5010

LUCIFERO
35W 12V MAX
GY6,35 230/12V



CE IP20

Base: Metallo
Stelo: Rame
Finitura: Cromo
Particolarità: Alluminio graffiato Nome "Lucifero" illuminato in blu e rosso sul coprilampada
Trasformatore: A spina
Lampadina: Alogena bispina
Peso e misure con imballo: 5 kg - 500 x 250 x 800 mm

Base: Metal
Stem: Copper
Finish: Chrome
Detail: Etched aluminium, the name "Lucifero" illuminated in blue and red on the lampshade
Transformer: with Plug
Lamp: Double plug-in Halogen
Weight and Measurements including Packaging: 5 kg - 500 x 250 x 800 mm

Socle: Métal
Pied: Cuivre
Finition: Chrome
Particularité: Aluminium gratté, nom "Lucifero" illuminé bleu et rouge sur l'abat-jour
Transformateur: À fiche
Ampoule: Halogène bi-pin
Poids et mesures avec emballage: 5 kg - 500 x 250 x 800 mm

Base: Metal
Tubo: Cobre
Acabado: Cromo
Particularidades: Aluminio rayado, Nombre "Lucifero" iluminado de azul y rojo en el cubrelámpara
Transformador: De enchufe
Bombilla: Halógena doble enchufe
Peso y medidas con embalaje: 5 kg - 500 x 250 x 800 mm



Cod. 5001

ARIOCH
35W MAX 12V Ø35
GU4 230/12V



CE IP20

Base: Plexiglas e specchio
Stelo: Acciaio
Finitura: Cromo
Particolarità: Specchio orientabile e sfere cromo nella base
Trasformatore: A spina
Lampadina: Dicroica
Peso e misure con imballo: 2,5 kg - 420 x 720 x 120 mm

Base: Plexiglas and mirror
Stem: Steel
Finish: Chrome
Detail: Revolving mirror and Chromium spheres in the base
Transformer: With plug
Lamp: Dichroic
Weight and Measurements including Packaging: 2,5 kg - 420 x 720 x 120 mm

Socle: Plexiglas et miroir
Pied: Acier
Finition: Chrome
Particularité: Miroir orientable et billes chromées à la base
Transformateur: À fiche
Ampoule: Dichroïque
Poids et mesures avec emballage: 2,5 kg - 420 x 720 x 120 mm

Base: Plexiglas y espejo
Tubo: Acero
Acabado: Cromo
Particularidades: Espejo orientable y esferas cromadas en la base
Transformador: De enchufe
Bombilla: Dicroica
Peso y medidas con embalaje: 2,5 kg - 420 x 720 x 120 mm

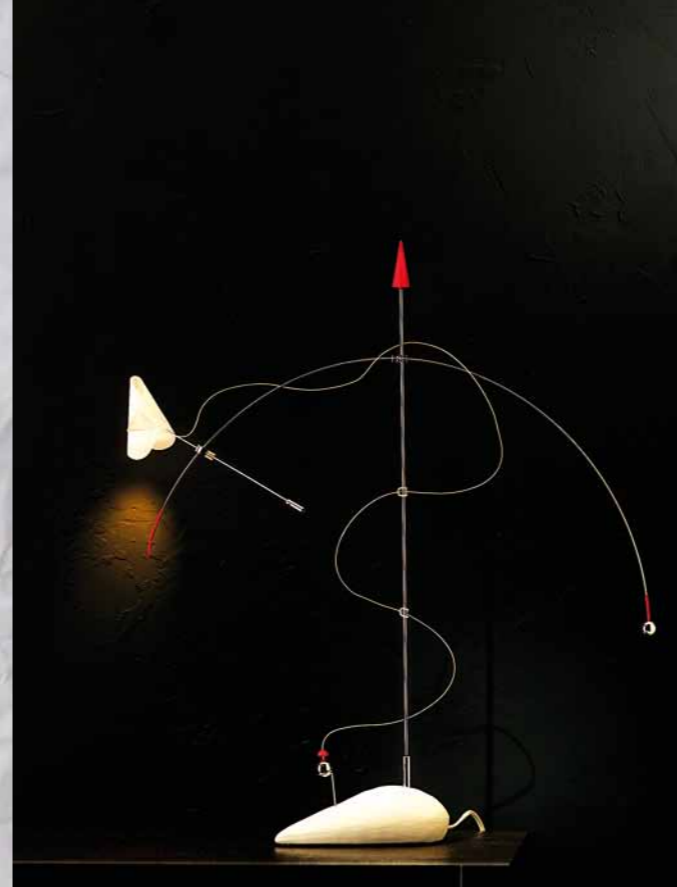

Cod. 5003

TITIVILUS
20W MAX 12V Ø35
GU4 230/12V



CE IP20

OPZIONE COLORE PUNTA:



Base: Terracotta bianca
Stelo: Acciaio
Finitura: Cromo
Particolarità: Coprilampada in vetro silicone e puntale colorato
Trasformatore: A spina
Lampadina: Dicroica
Peso e misure con imballo: 2 kg - 420 x 720 x 120 mm

Base: White terra-cotta
Stem: Steel
Finish: Chrome
Detail: Silicone-glass lampshade and coloured point
Transformer: With plug
Lamp: Dichroic
Weight and Measurements including Packaging: 2 kg - 420 x 720 x 120 mm

Socle: Terre cuite blanche
Pied: Acier
Finition: Chrome
Particularité: Abat-jour en verre siliciné et embout coloré
Transformateur: À fiche
Ampoule: Dichroïque
Poids et mesures avec emballage: 2 kg - 420 x 720 x 120 mm

Base: Terracota blanca
Tubo: Acero
Acabado: Cromo
Particularidades: Cubrelámpara de cristal silicona y punta coloreada
Transformador: De enchufe
Bombilla: Dicroica
Peso y medidas con embalaje: 2 kg - 420 x 720 x 120 mm

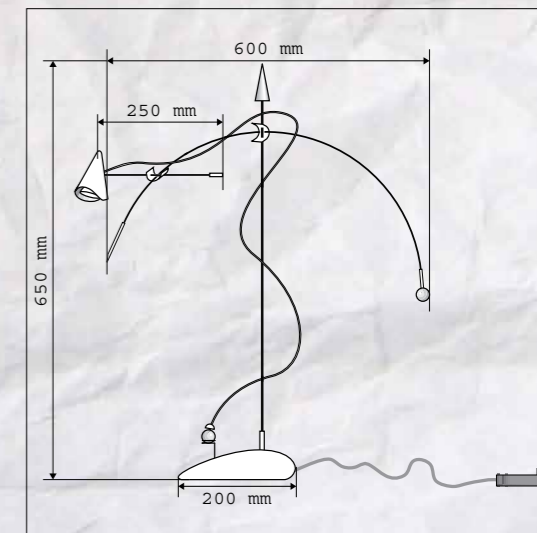
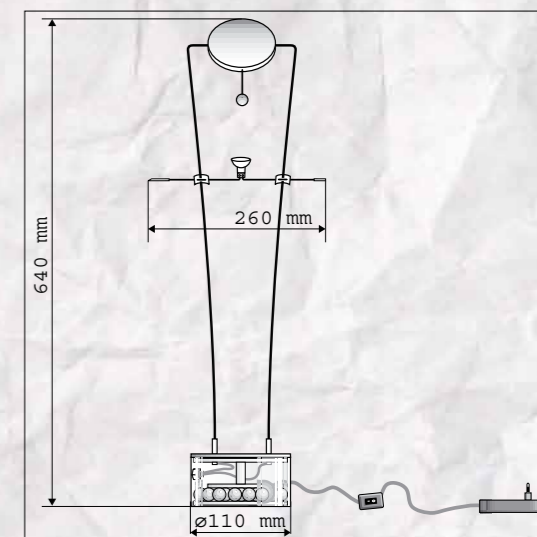
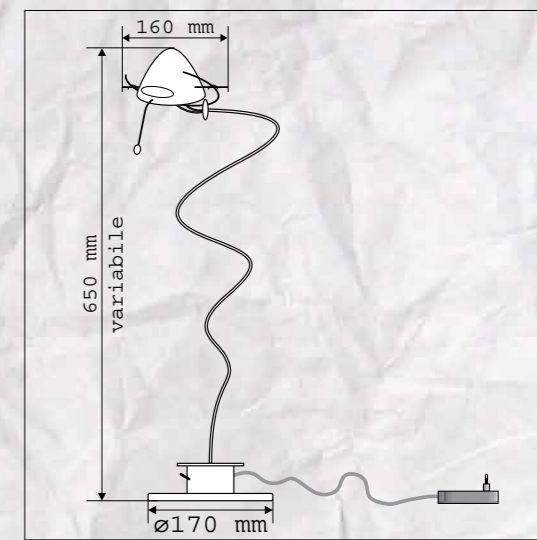





Cod. 5004

ECHIDNA
50W MAX | 2V Ø5 I
GU5,3 230/12V



CE IP20   

Base: Terracotta rossa
Stelo: Rame
Finitura: Cromo
Particolarità: Coprilampada in vetro silicone
Trasformatore: Elettronico inserito nella base
Lampadina: Dicroica
Peso e misure con imballo: 3 kg - 500 x 250 x 800 mm

Base: Red terra-cotta
Stem: Copper
Finish: Chrome
Detail: Silicone-glass lampshade
Transformer: Electronic within the base
Lamp: Dichroic
Weight and Measurements including Packaging: 3 kg - 500 x 250 x 800 mm

Socle: Terre cuite rouge
Tige: Cuivre
Finition: Chrome
Particularité: Abat-jour en verre siliciné
Transformateur: Électronique inséré dans le socle
Ampoule: Dichroïque
Poids et mesures avec emballage: 3 kg - 500 x 250 x 800 mm



Base: Terracota roja
Tubo: Cobre
Acabado: Cromo
Particularidades: Cubrelámpara de cristal silicona
Transformador: Electrónico introducido en la base
Bombilla: Dicroica
Peso y medidas con embalaje: 3 kg - 500 x 250 x 800 mm



Cod. 5007

FLORIA
2 x 20W MAX | 2V Ø35
GU4 230/12V



CE IP20   

Base: Terracotta rossa
Stelo: Rame
Finitura: Cromo
Particolarità: Cavi teflon verdi coprilampada vetro silicone
Trasformatore: Toroidale inserito nella base
Lampadina: Dicroica
Peso e misure con imballo: 3 kg - 200 x 200 x 660 mm

Base: Red terra-cotta
Stem: Copper
Finish: Chrome
Detail: Green teflon cables silicone-glass lampshade
Transformer: Toroidal within the base
Lamp: Dichroic
Weight and Measurements including Packaging: 3 kg - 200 x 200 x 660 mm

Socle: Terre cuite rouge
Pied: Cuivre
Finition: Chrome
Particularité: Câbles téflon verts, abat-jour en verre siliciné
Transformateur: Toroidal inséré dans le socle
Ampoule: Dichroïque
Poids et mesures avec emballage: 3 kg - 200 x 200 x 660 mm

Base: Terracota roja
Tubo: Cobre
Acabado: Cromo
Particularidades: Cables teflón verdes, cubrelámpara de cristal silicona
Transformador: Toroidal introducido en la base
Bombilla: Dicroica
Peso y medidas con embalaje: 3 kg - 200 x 200 x 660 mm



Cod. 5009

SHAKIRA
50W MAX | 2V Ø5 I
GU5,3 230/12V



CE IP20   

Base: Ottone
Stelo: Rame
Finitura: Cromo
Particolarità: Tessuto in ottone nichelato
Trasformatore: Elettronico inserito nella base
Lampadina: Dicroica (blu)
Peso e misure con imballo: 5 kg - 1.130 x 450 x 260 mm

Base: Brass
Stem: Copper
Finish: Chrome
Detail: Nickel-plated brass tissue
Transformer: Electronic within the base
Lamp: Dichroic (blue)
Weight and Measurements including Packaging: 5 kg - 1.130 x 450 x 260 mm

Socle: Laiton
Pied: Cuivre
Finition: Chrome
Particularité: Tissu en laiton nickelé
Transformateur: Électronique inséré dans le socle
Ampoule: Dichroïque (bleue)
Poids et mesures avec emballage: 5 kg - 1.130 x 450 x 260 mm

Base: Laton
Tubo: Cobre
Acabado: Cromo
Particularidades: Tejido de latón niquelado
Transformador: Electrónico introducido en la base
Bombilla: Dicroica (azul)
Peso y medidas con embalaje: 5 kg - 1.130 x 450 x 260 mm

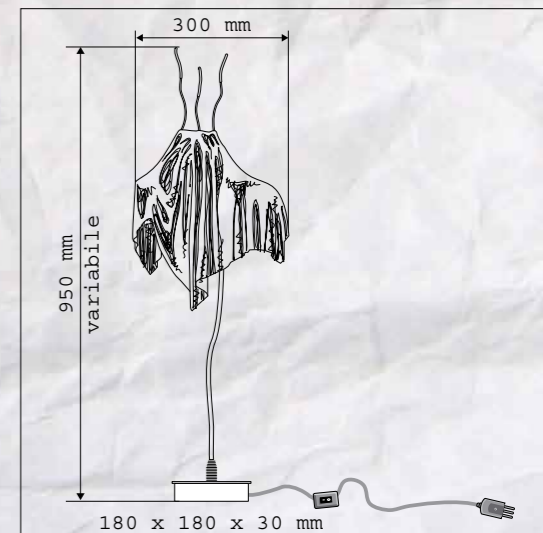
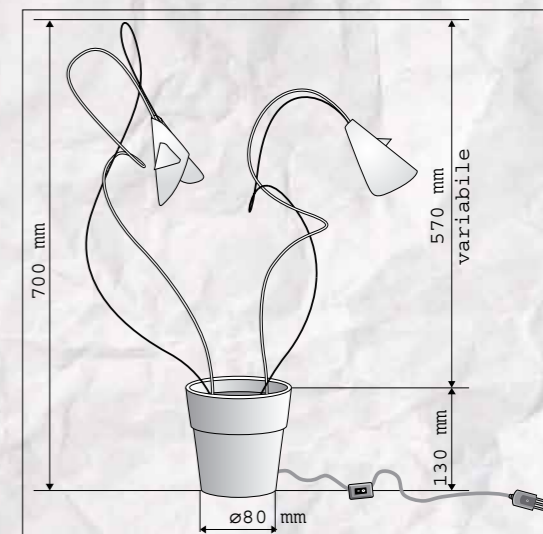
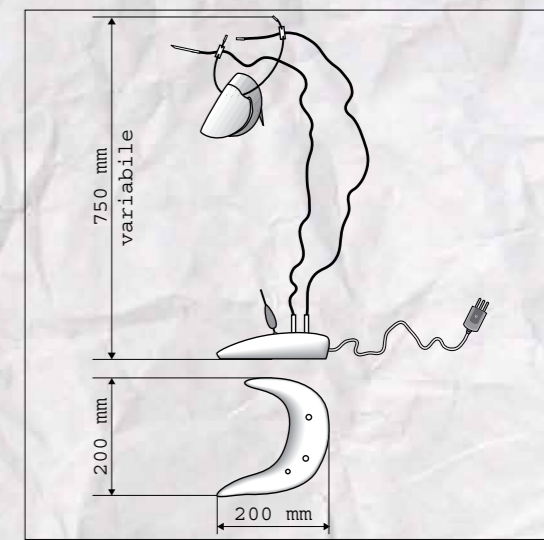



Cod. 5014

S E R E N D I B
 1 x 60W MAX 12V
 E27 230/12V
 LED SMD 1,4W 12V

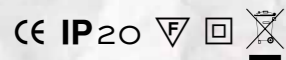

Base: Plexiglas
 Sfera: Policarbonato
 Particolarità: Pellicola iridescente nella base
 Trasformatore e alimentatore LED: inseriti nella base
 Lampadina: a Goccia E27 12V
 LED SMD: Colore blu
 Peso e misure con imballo: 8 kg - 540 x 540 x 620 mm

Base: Plexiglas
 Sphere: Polycarbonate
 Detail: Iridescent film on base
 Transformer and LED power supply: Within the base
 Bulb: E27 12V light bulb
 LED SMD: Blue colour
 Weight and Measurements including Packaging: 8 kg - 540 x 540 x 620 mm

Socle: Plexiglas
 Sphère: Polycarbonate
 Particularité: Pellicule iridescente dans le socle
 Transformateur et alimentateur: Insérés dans le socle
 Ampoule: Goutte E27 12V
 LED SMD: Couleur bleu
 Poids et mesures avec emballage: 8 kg - 540 x 540 x 620 mm

Base: Plexiglas
 Esfera: Policarbonato
 Particularidades: Pellicula iridescente en la base
 Transformador y alimentador LED: Introducidos en la base
 Bombilla: Gota E27 12V
 LED SMD: Color azul
 Peso y medidas con embalaje: 8 kg - 540 x 540 x 620 mm



Cod. 6027

IL FRUTTO DEL PECCATO
 40W (60W MAX)
 E14 230V

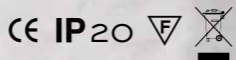

Base: Piatto in ceramica
 Stelo: Flessibile in ottone
 Finitura: Cromo
 Particolarità: Mela e forchetta sul piatto
 Lampadina: Colpo di vento
 Peso e misure con imballo: 2,8 kg - 420 x 720 x 120 mm

Base: Ceramic plate
 Stem: Brass flexible stem
 Finish: Chrome
 Detail: Apple and fork on the plate
 Lamp: Gust of wind
 Weight and Measurements including Packaging: 2,8 kg - 420 x 720 x 120 mm

Socle: Assiette en céramique
 Pied: Flexible en laiton
 Finition: Chrome
 Particularité: Pomme et fourchette sur l'assiette
 Ampoule: Coup de vent
 Poids et mesures avec emballage: 2,8 kg - 420 x 720 x 120 mm

Base: Plato de cerámica
 Tubo: Flexible de latón
 Acabado: Cromo
 Particularidades: Manzana y tenedor en el plato
 Bombilla: Golpe de viento
 Peso y medidas con embalaje: 2,8 kg - 420 x 720 x 120 mm



LUCIFERO

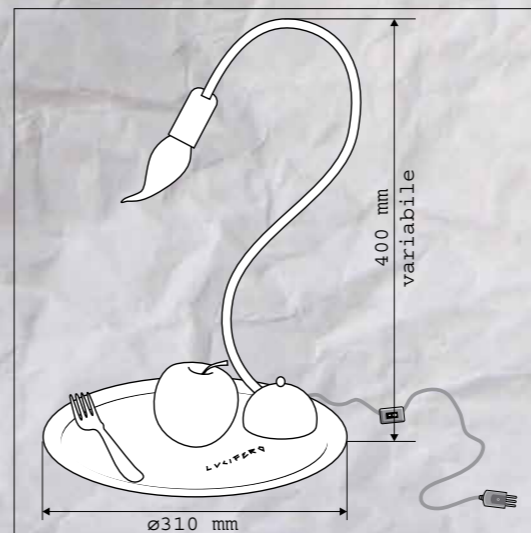
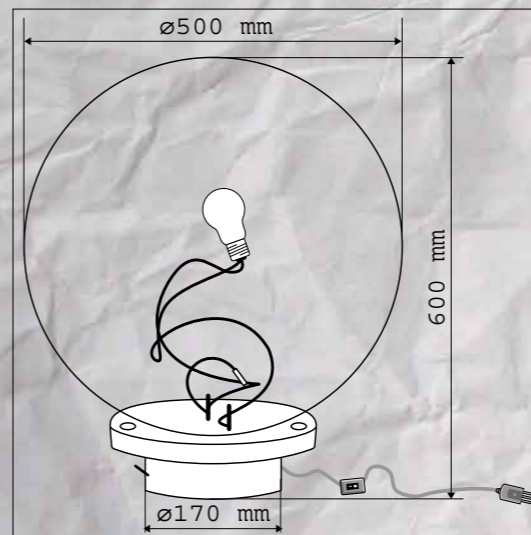



Hotel Star - Milano



Hotel Star - Milano



Hotel Star - Milano



Hotel Star - Milano



Hotel Star - Milano



Hotel Star - Milano

LUCIFERO VÀ IN CROCIERA...

Lucifero Illuminazione ha realizzato per Costa Crociere nr. 33 opere luminose da installare all'interno del Casinò Flamingo della nave Costa Pacifica, ammiraglia della flotta Costa Crociere inaugurata il 5 Giugno 2009 insieme alla nave Costa Luminosa in un evento entrato nel Guinness World Record 2009.

Coordinamento e Consulenza Tecnica:
Studio Cervi & Rossi

METAMORFOSI ONIRICA DELLA LUCE.

Lucifero si è ispirato al mondo ludico del Casinò dove la luce brilla illuminando il fascino e il mistero del gioco. In questo luogo luccicante, occhi dipinti e mani vigorose giocano cercando il segreto della fortuna.

La collezione delle opere luminose ha seguito un percorso creativo attingendo all'arcano ed intrigante mondo femminile.

La luce rappresenta il sogno della vita, essa è il cibo della nostra anima.

Chi non ha luce in viso, mai potrà essere stella.
(William Blake)

LUCIFERO GOES ON A CRUISE...

Lucifero company has produced for Costa Crociere 33 lamps which were setup in the inner Casino Flamingo of "Costa Pacifica", the admiral-ship of Costa Crociere cruise ships. This ship was inaugurated on June 5th 2009 at the same time of the inauguration of the ship "Costa Luminosa" during an event which entered the Guinness World Record 2009.

Coordination and technical advice:
Studio Cervi & Rossi

A DREAMLIGHT METAMORPHOSIS OF THE LIGHT.

Lucifero took its inspiration from the game world of the casino where the light illuminates the charm and mystery of gambling. In this glamorous place painted eyes and energetic hands search for the secret of luck.

The collection of light creations followed a creative path drawing on the enigmatic and glamorous female world.

The light represents the dream of life - it is the food of our soul.

He whose face gives no light, shall never become a star.
(William Blake)

LUCIFERO PART EN CROISIÈRE...

Lucifero Illuminazione a réalisé pour Costa Crociere 33 lampes qui ont été installées à l'intérieur du Casino Flamingo du «Costa Pacifica», vaisseau amiral de la flotte Costa Crociere, qui a été inauguré le 5 juin 2009 en même temps que le «Costa Luminosa» lors d'un événement entré dans le Guinness World Record 2009.

Coordination et consultation technique:
Cabinet Cervi & Rossi

METAMORPHOSES ONIRIQUE DE LA LUMIÈRE

Lucifero s'est inspiré au monde ludique du casino où la lumière brille illuminant l'envoûtement et le mystère du jeu. Dans ce lieu fascinant, des yeux et des mains vigoureuses jouent cherchant le secret de la chance.

La collection des oeuvres lumineuses a suivi un parcours créatif puisant dans l'énigmatique et séduisant monde féminin.

La lumière représente le rêve de la vie; elle est la nourriture de notre âme.

Qui ne possède pas la lumière sur son visage ne pourra jamais être une étoile.
(William Blake)

LUCIFERO ESTÁ EN CRUCERO...

Lucifero Illuminazione ha realizado para Costa Crociere n° 33 obras luminosas instaladas en el interior del Casino Flamingo de la nave Costa Pacifica, buque insignia de la flota Costa Crociere inaugurada el 5 de junio de 2009 junto con la nave Costa Luminosa en un evento que ha entrado en el Guinness World Record de 2009.

Coordinación y asesoramiento técnico:

Estudio Cervi & Rossi

METAMÓRFOSIS ONÍRICA DE LA LUZ

Lucifero se ha inspirado en el mundo lúdico del Casino donde la luz brilla iluminando la fascinación y el misterio del juego. En este lugar brillante, ojos pintados y manos vigorosas juegan buscando el secreto de la fortuna.

La colección de las obras luminosas ha seguido un camino creativo inspirándose en el arcano e intrigante mundo femenino.

La luz representa el sueño de la vida, ella es el alimento de nuestra alma.

Quien no tenga luz en el rostro, nunca podrá ser estrella.
(William Blake)



Video
Costa Deliziosa



Costa Crociere
Nave Costa Pacifica

Video
Costa Pacifica
Casinò Flamingo



Costa Crociere
Nave Costa Deliziosa

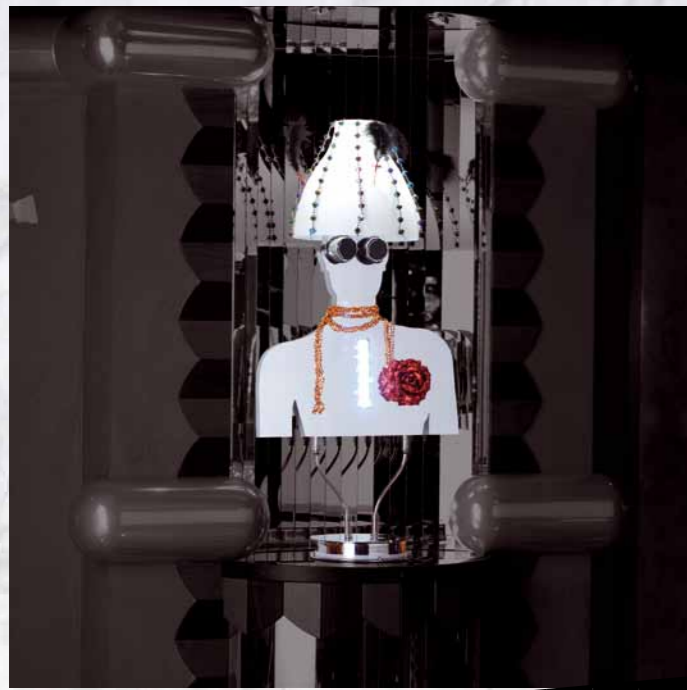

ESECUZIONI SPECIALI



SPECIAL WORKS

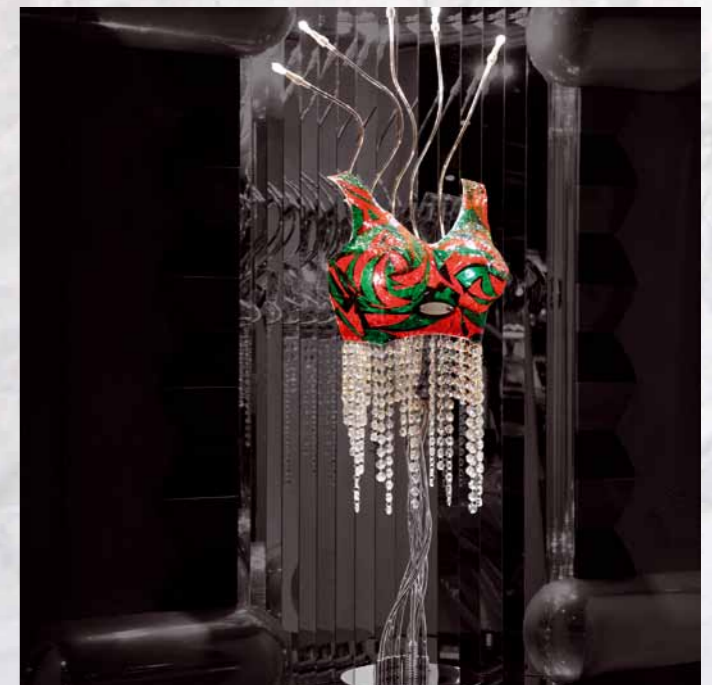
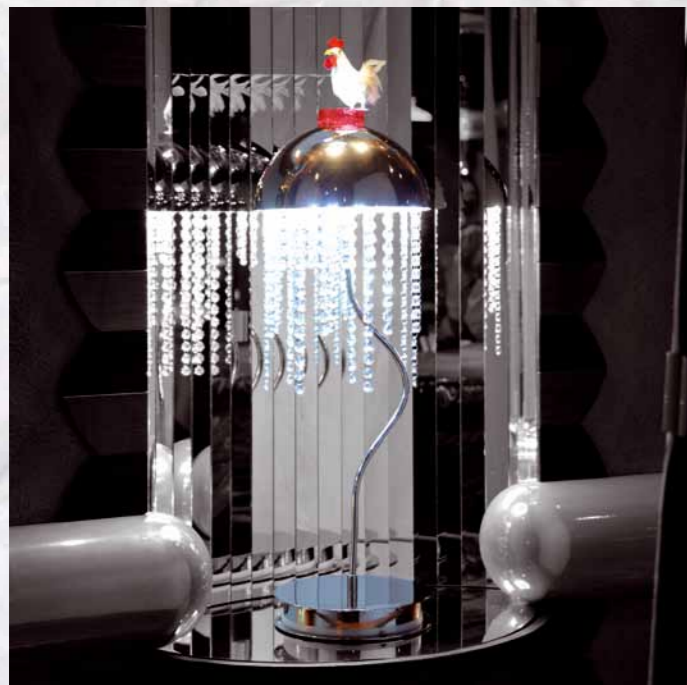

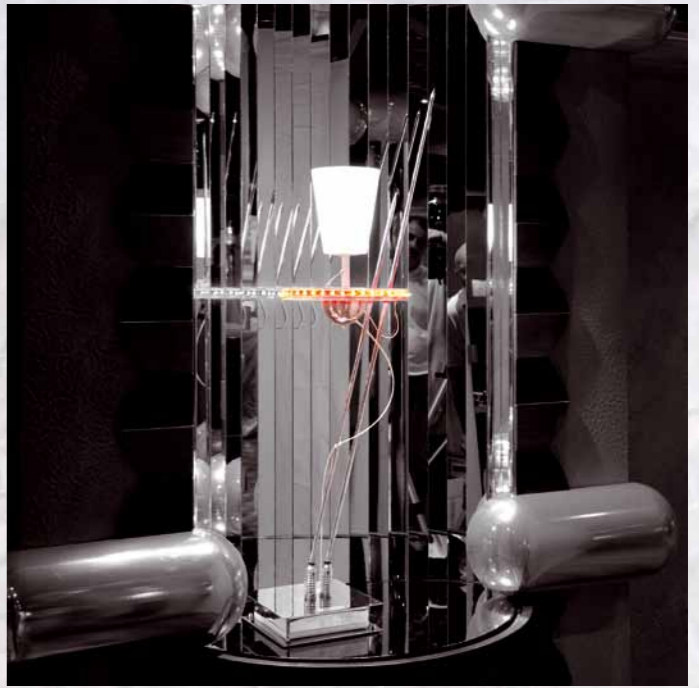

ESECUZIONI SPECIALI

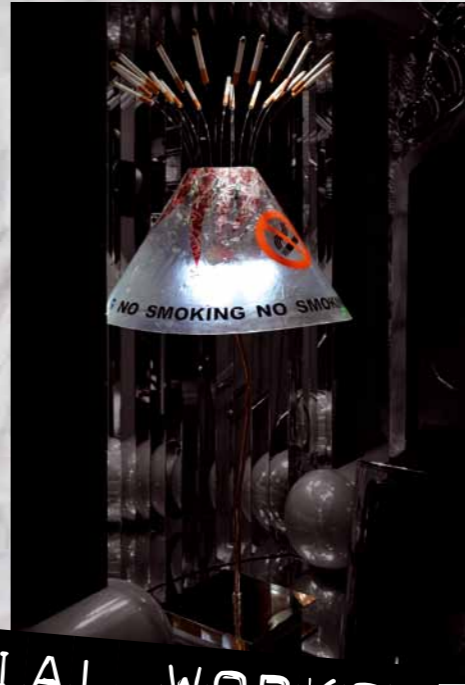

SPECIAL WORKS

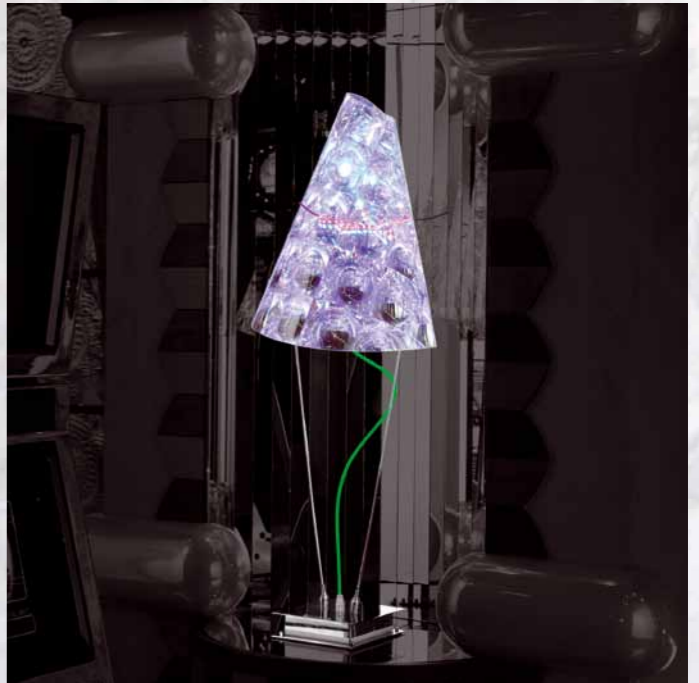
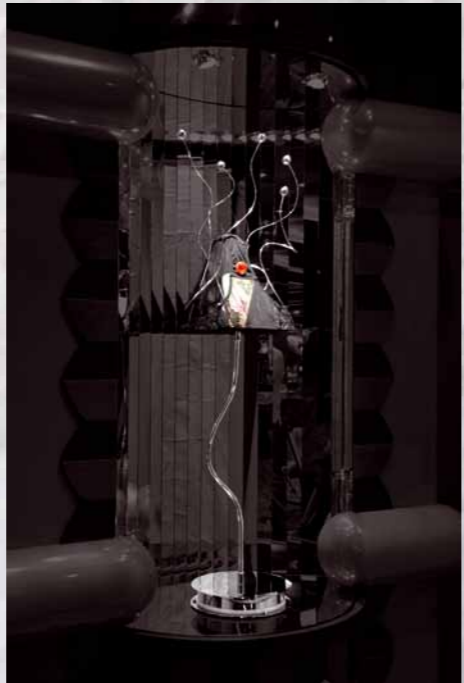

La luce che brilla il doppio dura la meta.
Jimi Hendrix



VILLA RIVOLI
SHAKIRA
TOQUI' BLACK
SERENDIS
TRIBAL

SOTTO IL
VESTITO NIENTE
CAYS
CRUCIS
FLOWERS

The Vision
YAKOM



Cod. 6047

OPZIONI: (CR)

C A Y P

3x35W MAX GY6,35 I 2V

220-240/12V

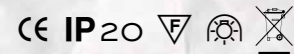

Base: Rame
 Opzione: Cromo cod. 6047CR
 Particolarità: Steli in rame isolato e fogli in alluminio ramato da un lato
 Trasformatore: Elettronico inserito nella base
 Lampadina: Alogena bispina
 Peso e misure con imballo: 2 kg - 250 x 410 x 500 mm

Base: Copper
 Options: Chrome code 6047CR
 Detail: Insulated copper stems and aluminium leaves on one side
 Transformer: Electronic within the base
 Bulb: Double plug-in halogen
 Weight and Measurements including Packaging: 2 kg - 250 x 410 x 500 mm

Base: Cuivre
 Option: Chrome code 6047CR
 Particularité: Tiges en cuivre isolé et feuilles en aluminium cuivré d'un côté
 Transformateur: Electronique inséré dans le socle
 Ampoule: Halogène bi-pin
 Poids et mesures avec emballage: 2 kg - 250 x 410 x 500 mm

Base: Cobre
 Opciones: Cromo cód. 6047CR
 Particularidades: Tubos de cobre aislado y folios de aluminio cobrizo a un lado
 Transformador: Electrónico introducido en la base
 Bombilla: Halógena doble enchufe
 Peso y medidas con embalaje: 2 kg - 250 x 410 x 500 mm



Cod. 6048

A R G E N S

1x22W 2GX13 Fc 230V

3x20W MAX G4 I 2V

220-240/12V

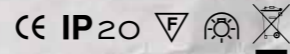

Base: In metallo cromato
 Steli: Cromati
 Frontale: Plexiglas iridescente
 Particolarità: Occhi serigrafati all'interno
 Trasformatore e Alimentatore: Elettronici inseriti nella base
 Lampadine: Alogena bispina e Fluorescente
 Peso e misure con imballo: 4,5 kg - 750 x 450 x 300 mm

Base: Chrome metal
 Stems: Chrome
 Front panel: Iridescent plexiglass
 Detail: Silk screen printed eyes on inside
 Transformer and power supply: Electronic within the base
 Bulb: Double plug-in halogen and fluorescent
 Weight and Measurements including Packaging: 4,5 kg - 750 x 450 x 300 mm

Base: En métal chromé
 Tiges: Chromé
 Frontal: En plexiglas iridescent
 Particularité: Yeux sérigraphiés à l'intérieur
 Transformateur et alimentateur: Électronique insérés dans la base
 Ampoule: Halogène bi-pin et fluorescente
 Poids et mesures avec emballage: 4,5 kg - 750 x 450 x 300 mm

Base: De metal cromado
 Tubos: Cromado
 Frontal: De plexiglas iridescente
 Particularidades: Ojos serigrafados en el interior
 Transformador y Alimentador: Electrónico introducidos en la base
 Bombilla: Halógena doble enchufe y Fluorescente
 Peso y medidas con embalaje: 4,5 kg - 750 x 450 x 300 mm



Cod. 6049

C R U C I S

11x20W MAX G4 I 2V

220-240/12V

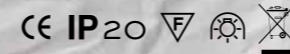

Base: Metallo
 Finitura: Cromo
 Particolarità: Pendenti in cristallo
 Trasformatori: Elettronici inseriti nella base
 Lampadina: Alogena bispina
 Peso e misure con imballo: 6 kg - 720 x 120 x 420 mm

Base: Metal
 Finish: Chrome
 Detail: Crystal pendants
 Transformers: Electronic within the base
 Bulb: Double plug-in halogen
 Weight and Measurements including Packaging: 6 kg - 720 x 120 x 420 mm

Base: Métal
 Finition: Chrome
 Particularité: Pendants en cristal
 Transformateurs: électroniques insérés dans la base
 Ampoule: Halogène bi-pin
 Poids et mesures avec emballage: 6 kg - 720 x 120 x 420 mm

Base: Metal
 Acabado: Cromo
 Particularidades: Colgantes de cristal
 Transformador y Alimentador: Electrónico introducidos en la base
 Bombilla: Halógena doble enchufe
 Peso y medidas con embalaje: 6 kg - 720 x 120 x 420 mm

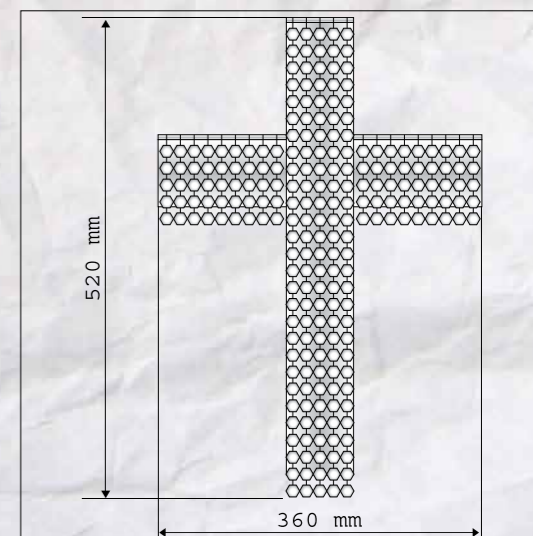
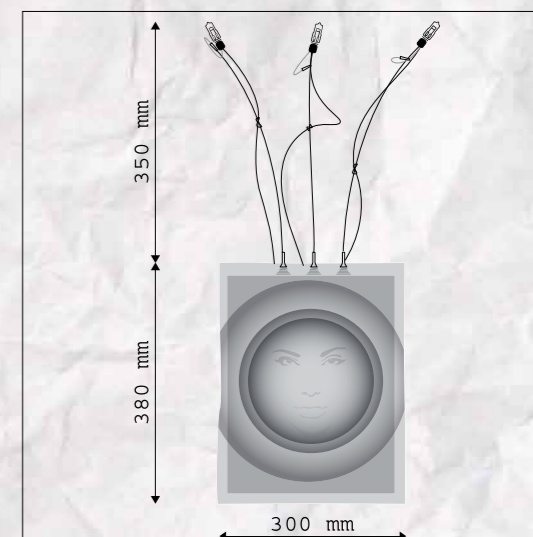
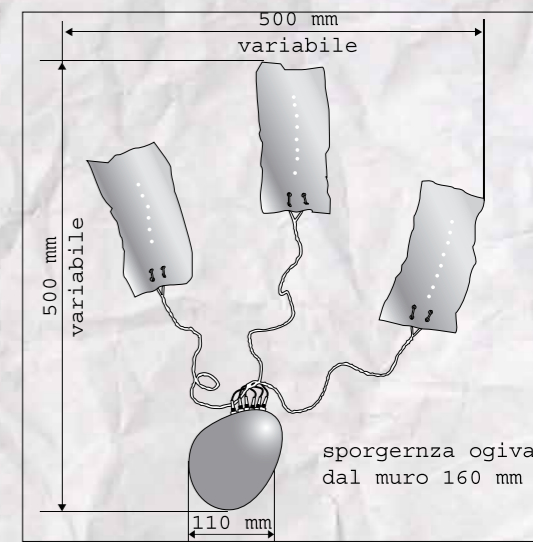

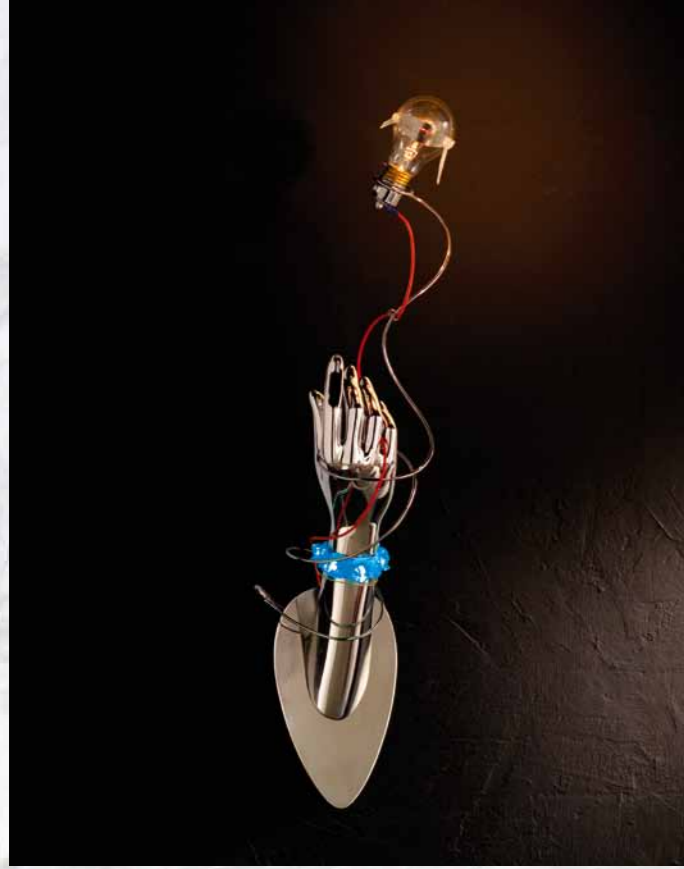

Cod. 6037
MASTIPHAL
 1 x 60W MAX
 E27 230/12V
 LED SMD 1,4W 12V



CE IP20

Base: Metallo
 Finitura: Cromo
 Braccio: Resina verniciato cromo
 Particolarità: Bracciale di LED blu
 Trasformatore: Elettronico e Alimentatore LED inseriti nella base
 Lampadina: Goccia E27 12V
 Peso e misure con imballo: 2,5 kg - 200 x 200 x 660 mm

Base: Metal
 Finish: Chrome
 Arm: Painted resin chrome
 Detail: Blue LED bracelet
 Transformer: Electronic within the base and LED power supply
 Bulb: E27 12V light bulb
 Weight and Measurements including Packaging: 2,5 kg - 200 x 200 x 660 mm

Base: Métal
 Finition: Chrome
 Bras: Résine peinte chrome
 Particularité: Bracelet de LED bleu
 Transformateur: Électronique et alimentateur LED insérés dans la base
 Ampoule: Goutte E27 12V
 Poids et mesures avec emballage: 2,5 kg - 200 x 200 x 660 mm

Base: Metal
 Acabado: Cromo
 Brazo: Resina barnizada cromo
 Particularidades: Anillo de LED azul
 Transformador: Electrónico y Alimentador LED introducidos en la base
 Bombilla: Gota E27 12V
 Peso y medidas con embalaje: 2,5 kg - 200 x 200 x 660 mm



Cod. 6035
FLINS
 1 x 60W MAX
 G9 230V



CE IP20

Base: Rame
 Finitura: Cromo
 Stelo: Flessibile in ottone cromato
 Particolarità: Orientabile
 Lampadina: Alogena
 Peso e misure con imballo: 1kg - 112 x 290 x 400 mm

Base: Copper
 Finish: Chrome
 Stem: Chrome flexible stem
 Detail: Revolving
 Lamp: Halogen
 Weight and Measurements including Packaging: 1kg - 112 x 290 x 400 mm

Base: Cuivre
 Finition: Chrome
 Tige: Flexible chromée
 Particularité: Orientable
 Ampoule: Halogène
 Poids et mesures avec emballage: 1 kg - 112 x 290 x 400 mm

Base: Cobre
 Acabado: Cromo
 Tubo: Flexible cromado
 Particularidades: Orientable
 Bombilla: Halógena
 Peso y medidas con embalaje: 1kg - 112 x 290 x 400 mm



Cod. 6038 CR
 OPZIONI: (ZB) (ZG)
DYERS
 5 x 20W MAX BISPINA
 G4 230/12V



CE IP20

Base: Metallo
 Stelo: Rame
 Finitura: Cromo (CR)
 Opzioni: Zincatura Bianca (ZB) Gialla (ZG)
 Particolarità: Steli Modellabili
 Trasformatore: Elettronico inserito nella base
 Lampadina: Alogena Bispina
 Peso e misure con imballo: 1,8 kg - 112 x 290 x 400 mm

Base: Metal
 Stem: Copper
 Finish: Chrome (CR)
 Options: White (ZB) Yellow (ZG) galvanized
 Detail: Mouldable stems
 Transformer: Electronic within the base
 Lamp: double plug-in halogen
 Weight and Measurements including Packaging: 1,8 kg - 112 x 290 x 400 mm

Base: Métal
 Tige: Cuivre
 Finition: Chrome (CR)
 Options: Zingage Blanc (ZB), Jaune (ZG)
 Particularité: Tiges modelables
 Transformateur: Électronique inséré dans la base
 Ampoule: Halogène bi-pin
 Poids et mesures avec emballage: 1,8 kg - 112 x 290 x 400 mm

Base: Metal
 Tubo: Cobre
 Acabado: Cromo (CR)
 Opciones: Galvanizado con zinc en Blanco (ZB) y Amarillo (ZG)
 Particularidades: Tubos moldeables
 Transformador: Electrónico introducido en la base
 Bombilla: Halógena doble enchufe
 Peso y medidas con embalaje: 1,8 kg - 112 x 290 x 400 mm

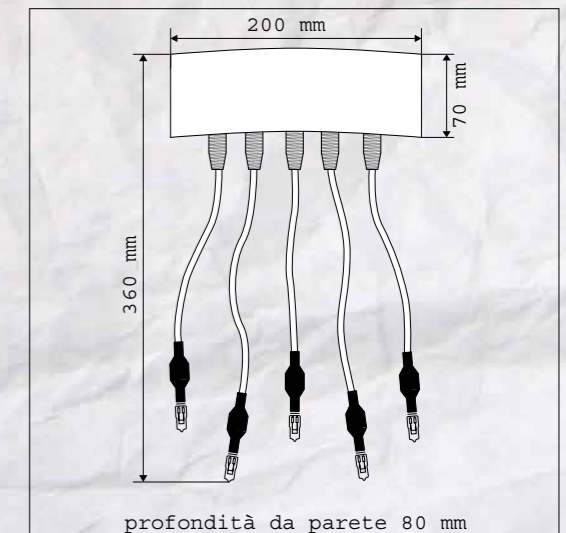
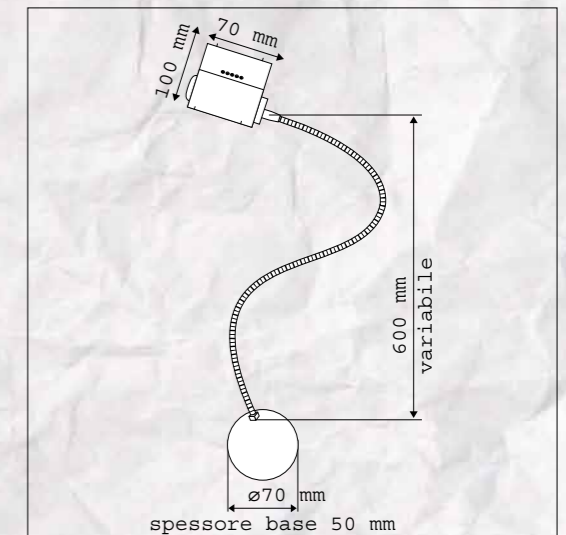
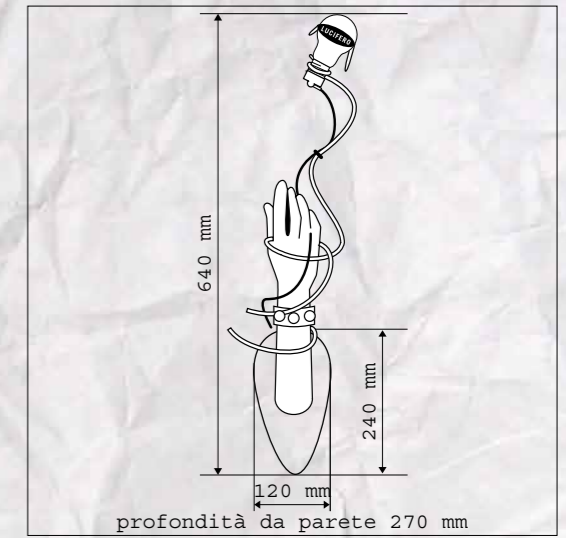



Cod. 6036 CR

OPZIONI: (ZB) (ZG)

FLAMEL

7 x 20W MAX

G4 230/12V

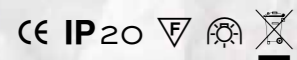

Base: Metallo
 Finitura: Cromo (CR)
 Opzioni: Zincatura Bianca (ZB) Gialla (ZG)
 Stelo: Flessibile in ottone cromato
 Particolarità: Steli Modellabili
 Trasformatore: Elettronico inserito nella base
 Lampadina: Alogena Bispina
 Peso e misure con imballo: 4 kg - 750 x 450 x 300 mm

Base: Metal
 Finish: Chrome (CR)
 Options: White (ZB) Yellow (ZG) galvanized
 Stem: Chrome flexible stem
 Detail: Mouldable stems
 Transformer: Electronic within the base
 Lamp: Double plug-in halogen
 Weight and Measurements including Packaging: 4 kg - 750 x 450 x 300 mm

Base: Métal
 Finition: Chrome (CR)
 Options: Zingage Blanc (ZB), Jaune (ZG)
 Tiges: Flexible chromées
 Particularité: Tiges modelables
 Transformateur: Électronique inséré dans la base
 Ampoule: Halogène bi-pin
 Poids et mesures avec emballage: 4 kg - 750 x 450 x 300 mm

Base: Metal
 Acabado: Cromo (CR)
 Opciones: Galvanizado con zinc en Blanco (ZB) Amarillo (ZG)
 Tubo: Flexible cromado
 Particularidades: Tubos Moldeables
 Transformador: Electrónico introducido en la base
 Bombilla: Halógena doble enchufe
 Peso y medidas con embalaje: 4 kg - 750 x 450 x 300 mm

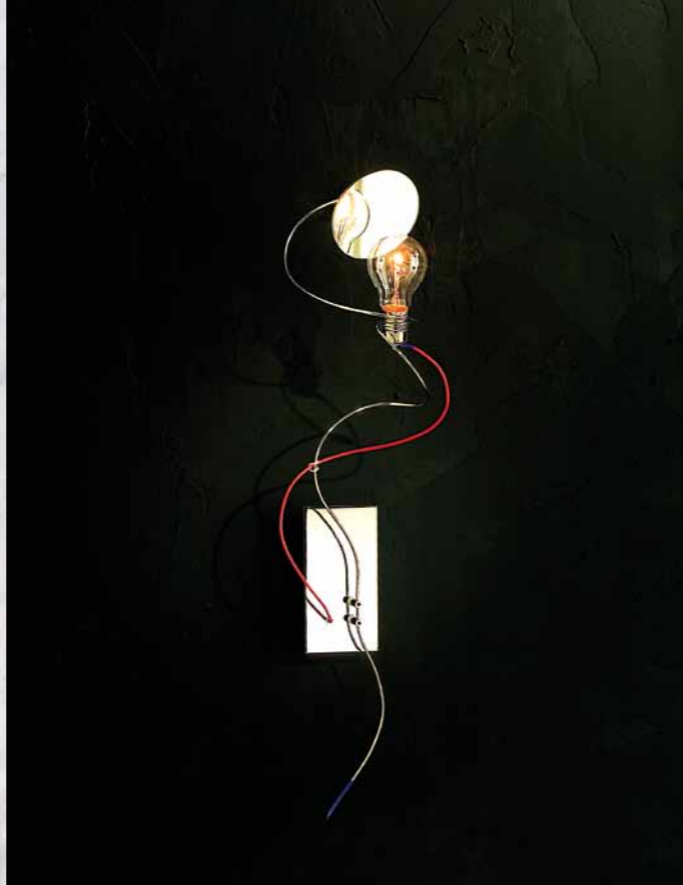

Cod. 6021

NARCISO

1 x 60W MAX

E27 230/12V

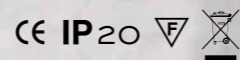

Base: Ottone
 Stelo: Rame
 Finitura: Cromo
 Particolarità: Specchio e cavo rosso
 Trasformatore: Elettronico inserito nella base
 Lampadina: Goccia E27 12V
 Peso e misure con imballo: 1,9 kg - 200 x 200 x 660 mm

Base: Brass
 Stem: Copper
 Finish: Chrome
 Detail: Mirror and red cable
 Transformer: Electronic within the base
 Bulb: E27 12V light bulb
 Weight and Measurements including Packaging: 1,9 kg - 200 x 200 x 660 mm

Base: Laiton
 Tige: Cuivre
 Finition: Chrome
 Particularité: Miroir et câble rouge
 Transformateur: Électronique inséré dans la base
 Ampoule: Goutte E27 12V
 Poids et mesures avec emballage: 1,9 kg - 200 x 200 x 660 mm

Base: Latón
 Tubo: Cobre
 Acabado: Cromo
 Particularidades: Espejo y cable rojo
 Transformador: Electrónico introducido en la base
 Bombilla: Gota E27 12V
 Peso y medidas con embalaje: 1,9 kg - 200 x 200 x 660 mm

LUCIFERO

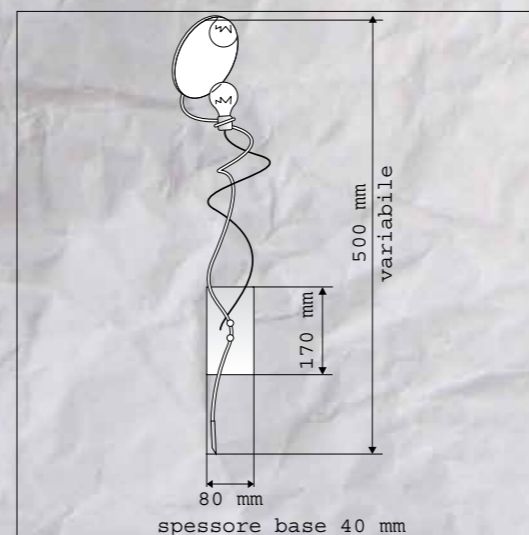
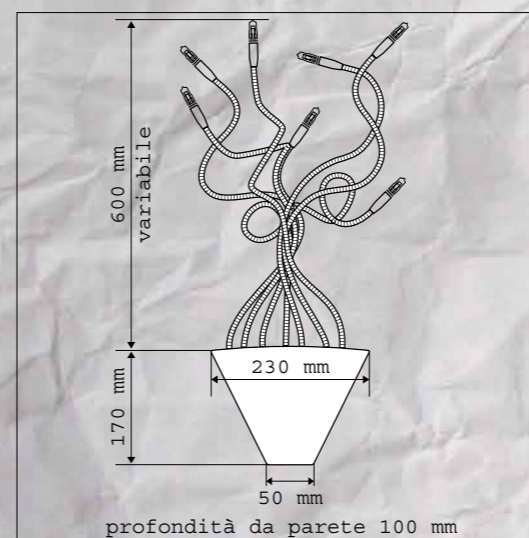



Cod. 6034

SOTTO IL VESTITO WALL

2 x 20W MAX G4 BISPINA 230/1 2V

2 x 35W MAX GU4 DICROICA Ø35 230/1 2V

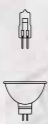

CE IP20

Base: Metallo
Finitura: Cromo
Busto: Metacrilato
Particolarità: Busto trattato con speciali pellicole iridescenti e finitura siliconica, Pendenti in cristallo
Trasformatore: Elettronico inserito nella base
Lampadina: Alogena Bispina e Dicroica
Peso e misure con imballo: 4 kg - 250 x 410 x 500 mm

Base: Metal
Finish: Chrome
Female bust: Acrylic
Detail: Bust coated with unique iridescent films and silicone coating, Chrystal pendants
Transformer: Electronic within the base
Lamp: Double plug-in halogen, dichroic
Weight and Measurements including Packaging: 4 kg - 250 x 410 x 500 mm

Base: Métal
Finition: Chrome
Buste: Métacrylique
Particolarité: Busto traité avec pellicules spéciales iridescentes et finition siliconée, Pendants en cristal
Transformateur: Électronique inséré dans la base
Ampoule: Halogène bi-pin et dichroïque
Poids et mesures avec emballage: 4 kg - 250 x 410 x 500 mm

Base: Metal
Acabado: Cromo
Busto: Metacrilado
Particularidades: Busto tratado con especiales películas iridescentes y acabado con silicona, Colgantes de cristal
Transformador: Electrónico introducido en la base
Bombilla: Halógena doble enchufe y Dicroica
Peso y medidas con embalaje: 4 kg - 250 x 410 x 500 mm



Cod. 6032 BLACK

E X I T

7 x 20W MAX G4 230/1 2V

1 x 9W E14 230V

RISPARMIO ENERGETICO / ENERGY SAVING



CE IP20

Busto: Resina
Steli: Cromati
Finitura: Naturale o Nero
Particolarità: Targa EXIT cromo, Retro illuminata rosso
Trasformatore: Elettronico inserito nella base
Lampadina: Alogena e a Risparmio Energetico
Peso e misure con imballo: 5,2 kg - 260 x 1.130 x 450 mm

Base: Resin
Stem: Chrome
Finish: Natural or black
Detail: Chrome plate "exit", rear red light
Transformer: Electronic within the base
Lamp: Halogen and energy saving
Weight and Measurements including Packaging: 5,2 kg - 260 x 1.130 x 450 mm

Buste: Résine
Tiges: Chromé
Finition: Naturelle et noir
Particolarité: Plaque exit chrome, arrière illuminé rouge
Transformateur: Electronique inséré dans la base
Ampoule: Halogène et à économie d'énergie
Poids et mesures avec emballage: 5,2 kg - 260 x 1.130 x 450 mm

Busto: Resina
Tubos: Cromado
Acabado: Natural y Negro
Particularidades: Placa EXIT cromo, detrás iluminado rojo
Transformador: Electrónico introducido en la base
Bombilla: Halógena y de bajo consumo energético
Peso e y medidas con embalaje: 5,2 kg - 260 x 1.130 x 450 mm



Cod. 6033 WHITE

E X I T

7 x 20W MAX G4 230/1 2V

1 x 9W E14 230V

RISPARMIO ENERGETICO / ENERGY SAVING



CE IP20

Busto: Resina
Steli: Cromati
Finitura: Naturale o Nero
Particolarità: Targa EXIT cromo, Retro illuminata rosso
Trasformatore: Elettronico inserito nella base
Lampadina: Alogena e a Risparmio Energetico
Peso e misure con imballo: 5,2 kg - 260 x 1.130 x 450 mm

Base: Resin
Stem: Chrome
Finish: Natural or black
Detail: Chrome plate "exit", rear red light
Transformer: Electronic within the base
Lamp: Halogen and energy saving
Weight and Measurements including Packaging: 5,2 kg - 260 x 1.130 x 450 mm

Buste: Résine
Tiges: Chromé
Finition: Naturelle et noir
Particolarité: Plaque exit chrome, arrière illuminé rouge
Transformateur: Electronique inséré dans la base
Ampoule: Halogène et à économie d'énergie
Poids et mesures avec emballage: 5,2 kg - 260 x 1.130 x 450 mm

Busto: Resina
Tubos: Cromado
Acabado: Natural y Negro
Particularidades: Placa EXIT cromo, detrás iluminado rojo
Transformador: Electrónico introducido en la base
Bombilla: Halógena y de bajo consumo energético
Peso e y medidas con embalaje: 5,2 kg - 260 x 1.130 x 450 mm

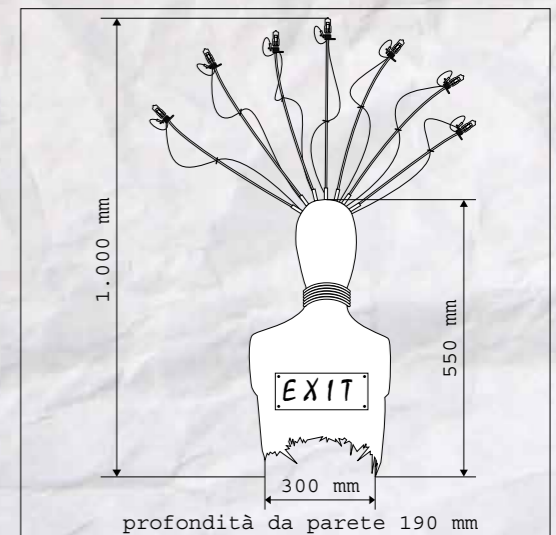
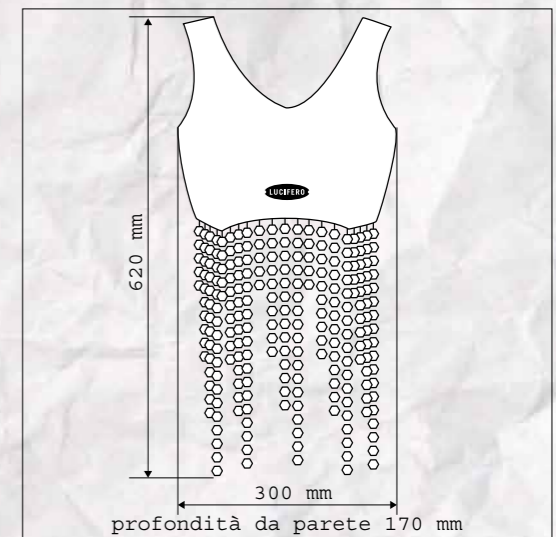

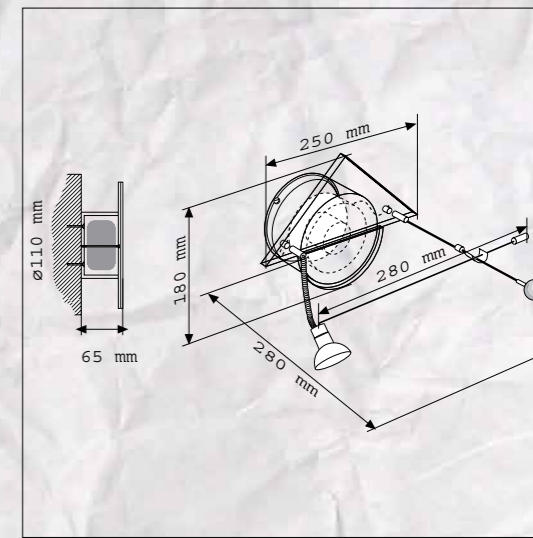
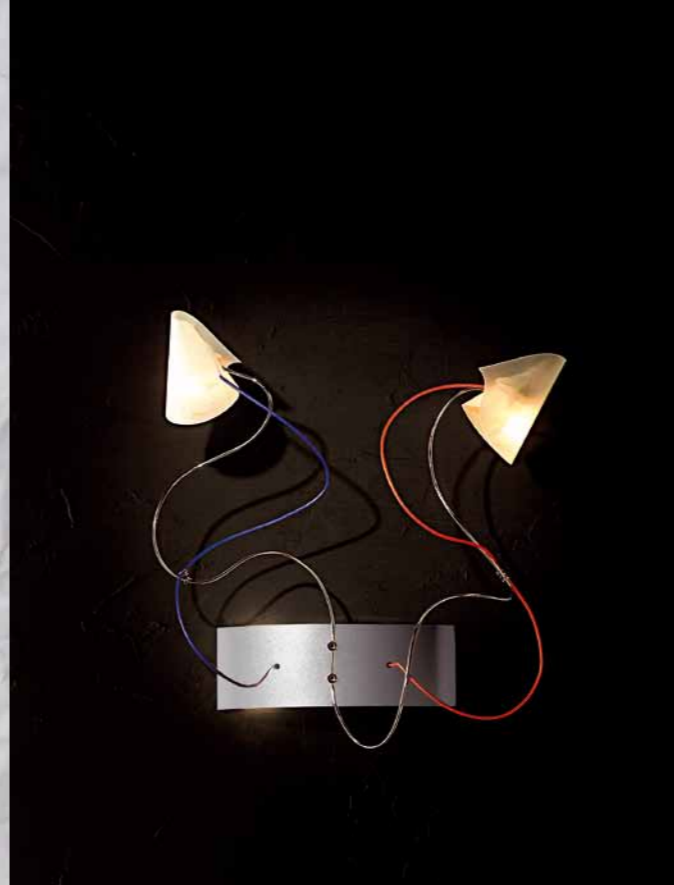

Cod. 6000

M O R A X

71W MAX | 2V Ø5 I
GU5,3 230/12V



CE IP20    

Base: Plexiglas
Stelo: Cromato
Particolarità: La sua trasparenza
Trasformatore: Toroidale inserito nella base
Lampadina: Dicroica
Peso e misure con imballo: 2,5 kg - 320 x 330 x 240 mm

Base: Plexiglas
Stem: Chrome
Detail: Its transparence
Transformer: Toroidal within the base
Lamp: Dichroic
Weight and Measurements including Packaging: 2,5 kg - 320 x 330 x 240 mm

Base: Plexiglas
Tige: Chrome
Particularité: Sa transparence
Transformateur: Toroidal inséré dans la base
Ampoule: Dichroïque
Poids et mesures avec emballage: 2,5 kg - 320 x 330 x 240 mm





Base: Plexiglas
Tubo: Cromo
Particularidades: Su transparencia
Transformador: Toroidal introducido en la base
Bombilla: Dicroica
Peso y medidas con embalaje: 2,5 kg - 320 x 330 x 240 mm

Cod. 6001 BIS

N E X R O T H

3 x 50W MAX | 2V Ø5 I
GU5,3 230/12V







CE IP20    

Cod. 6001 TER

N E X R O T H

4 x 50W MAX | 2V Ø5 I
GU5,3 230/12V



CE IP20    

Base: Metallo verniciato + specchio
Steli: Cromati
Particolarità: Specchio sulla base
Trasformatore: Toroidale inserito nella base
Lampadina: Dicroica
Peso e misure con imballo: 7 kg - 320 x 1.180 x 140 mm

Base: Painted Metal + Mirror
Stems: Chrome
Detail: Mirror on the base
Transformer: Toroidal within the base
Lamp: Dichroic
Weight and Measurements including Packaging: 7 kg - 320 x 1.180 x 140 mm

Base: Métal peint + miroir
Tiges: Chromées
Particularité: Miroir sur le socle
Transformateur: Toroidal inséré dans la base
Ampoule: Dichroïque
Poids et mesures avec emballage: 7 kg - 320 x 1.180 x 140 mm

Base: Metal Barnizado + espejo
Tubo: Cromo
Particularidades: Espejo en la base
Transformador: Toroidal introducido en la base
Bombilla: Dicroica
Peso y medidas con embalaje: 7 kg - 320 x 1.180 x 140 mm

N.B.: INSTALLAZIONE PARETE O SOFFITTO

Cod. 6011

Y I N Y A N G

2 x 50W MAX | 2V
GY6,35 230/12V



CE IP20    

Base: Acciaio inox
Stelo: rame cromato
Finitura: (base) acciaio inox (Frontale) verniciato grigio
Particolarità: Coprilampada in vetro silicone e cavi rosso e blu
Trasformatore: Elettronico inserito nella base
Lampadina: Alogena bispina
Peso e misure con imballo: 2,3 kg - 500 x 410 x 250 mm
Opzioni: Cavi trasparenti

Base: Acier inox
Tige: Cuivre chromé
Finition: (base) acier inox, (frontal) peint gris
Particularité: Abat-jour en verre silicone, câbles rouges et bleus
Transformateur: Électronique inséré dans la base
Ampoule: Halogène bi-pin
Poids et mesures avec emballage: 2,3 kg - 500 x 410 x 250 mm
Opzioni: Câbles transparents

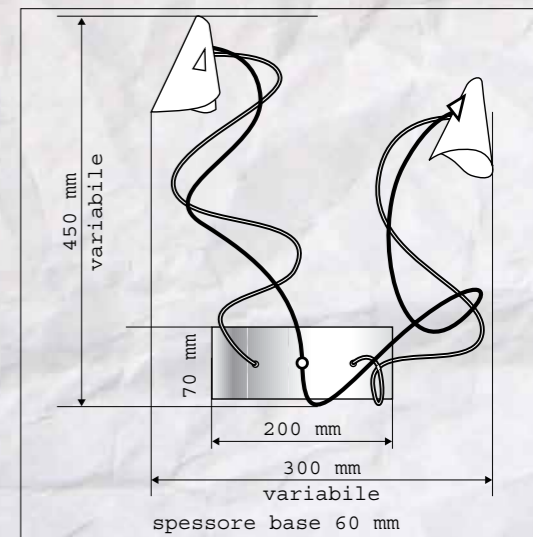
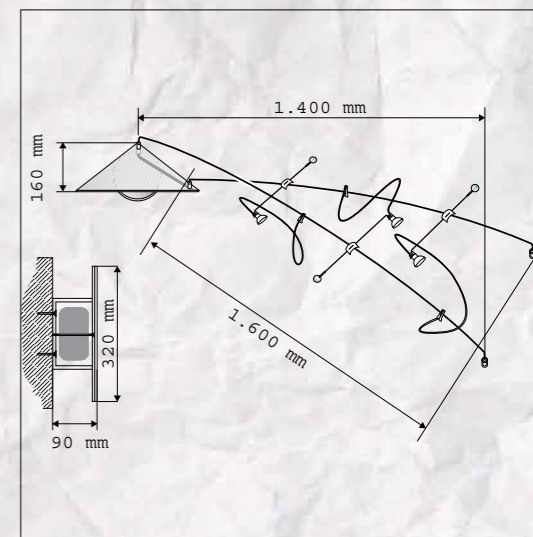

Base: Stainless steel
Stem: Chrome copper
Finish: (base) stainless steel - (Front Panel) grey paint
Detail: Silicone-glass lampshade, red and blue cables
Transformer: Electronic within the base
Lamp: Double plug-in halogen
Weight and Measurements including Packaging: 2,3 kg - 500 x 410 x 250 mm
Options: Transparent cables

Base: Acero inox
Tubo: Bronce Cromado
Acabado: (base) acero inox, (frontal) Barnizado gris
Particularidades: Cubrelámpara de cristal silicona y cables rojo y azul
Transformador: Electrónico introducido en la base
Bombilla: Halógena doble enchufe
Peso y medidas con embalaje: 2,3 kg - 500 x 410 x 250 mm
Opciones: Cables transparentes





Cod. 6013
P U C K
 100W MAX
 E27 HEG 220 -240V

CE IP20   

Base: Alluminio verniciato grigio
 Stelo: Cromato
 Particolarità: Coprilampada in vetro silicone
 Lampadina: Alogena doppio involucro
 Peso e misure con imballo: 1,2 kg - 320 x 330 x 240 mm



Base: Gray paint aluminium
 Stem: Chrome
 Detail: Silicone-glass lampshade
 Lamp: Double wrapping halogen
 Weight and Measurements including Packaging: 1,2 kg - 320 x 330 x 240 mm

Base: Aluminium peint gris
 Tige: Chromé
 Particularité: Abat-jour en verre siliconé
 Ampoule: Halogène double enveloppe
 Poids et mesures avec emballage: 1,2 kg - 320 x 330 x 240 mm

Base: Aluminio barnizado gris
 Tubo: Cromo
 Particularidades: Cubrelámpara de cristal silicona
 Bombilla: Halógena doble envoltura
 Peso y medidas con embalaje: 1,2 kg - 320 x 330 x 240 mm



Cod. 6015
Z O T A P P L I Q U E
 150W MAX
 R7s 230V

CE IP20   

Base: Alluminio verniciato grigio
 Stelo: Cromato
 Particolarità: Cavi trasparenti e collare cromato
 Lampadina: Alogena lineare corta
 Peso e misure con imballo: 1 kg - 400 x 290 x 112 mm



Base: Grey paint aluminium
 Stem: Chrome
 Detail: Transparent cables and chromium plated collar
 Lamp: Linear short halogen
 Weight and Measurements including Packaging: 1 kg - 400 x 290 x 112 mm

Base: Aluminium peint gris
 Tige: Chrome
 Particularité: Câbles transparents et collier chromé
 Ampoule: Halogène linéaire courte
 Poids et mesures avec emballage: 1 kg - 400 x 290 x 112 mm

Base: Aluminio barnizado gris
 Tubo: Cromo
 Particularidades: Cables transparentes y corona cromada
 Bombilla: Halógena lineal corta
 Peso y medidas con embalaje: 1 kg - 400 x 290 x 112 mm



Cod. 6030 ZG
Cod. 6030 ZB
Z E U S F A B E R
 3 x 20W MAX
 G4 230/12V

CE IP20   

Base: Metallo spazzolato
 Stelo: Rame zincatura bianca
 Finitura: Zincatura gialla (ZG)
 Opzione: Zincatura bianca (ZB)
 Particolarità: Finitura siliconica sul pesce
 Trasformatore: Elettronico inserito nella base
 Lampadina: Alogena bispina
 Peso e misure con imballo: 2,6 kg - 500 x 410 x 250 mm

Base: Brushed metal
 Stem: Copper white galvanized
 Finish: Yellow galvanized (ZG)
 Option: White galvanized (ZB)
 Detail: Silicone finish on the fish
 Transformer: Electronic within the base
 Lamp: Double plug-in halogen
 Weight and Measurements including Packaging: 2,6 kg - 500 x 410 x 250 mm

Base: Métal brossé
 Tiges: Cuivre zingage blanc
 Finition: Zingage jaune (ZG)
 Option: Zingage blanc (ZB)
 Particularité: Finition siliconée sur le poisson
 Transformateur: Électronique inséré dans la base
 Ampoule: Halogène bi-pin
 Poids et mesures avec emballage: 2,6 kg - 500 x 410 x 250 mm

Base: Metal cepillado
 Tubo: Cobre galvanizado con zinc en Blanco
 Acabado: Galvanizado con zinc en Amarillo (ZG)
 Opciones: Galvanizado con zinc en Blanco (ZB)
 Particularidades: Acabado con silicona en el pez
 Transformador: Electrónico introducido en la base
 Bombilla: Halógena doble enchufe
 Peso y medidas con embalaje: 2,6 kg - 500 x 410 x 250 mm

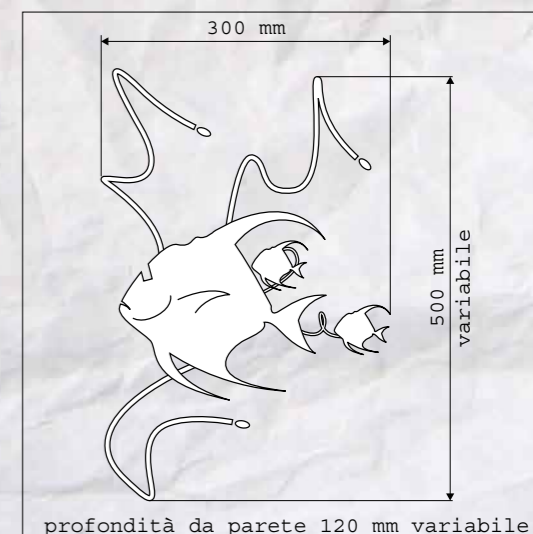
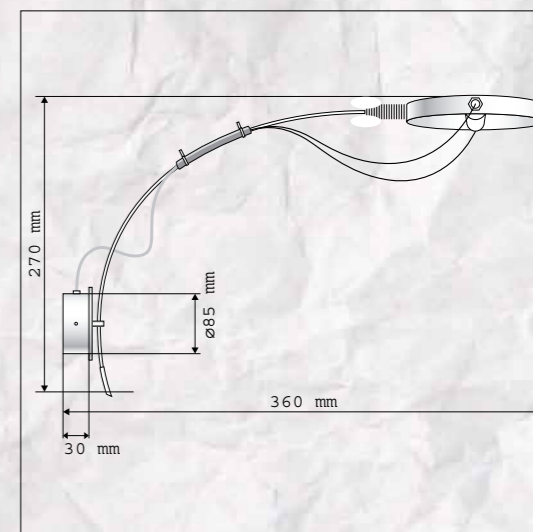
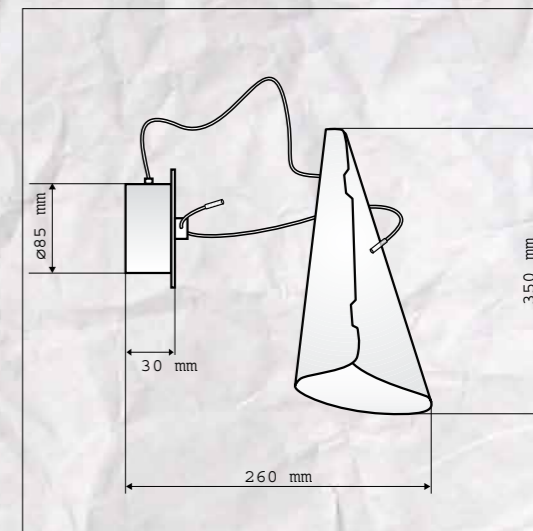



Cod. 6017 ZG

OPZIONI: (CR) (VB) (VNM) (ZB)

A N E I S

3 x 40W (60W MAX) E 14 230V

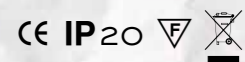

Cod. 6017 VNM

OPZIONI: (CR) (VB) (ZB) (ZG)

A N E I S

3 x 40W (60W MAX) E 14 230V

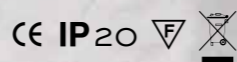

Cod. 6017 VB

OPZIONI: (CR) (VNM) (ZB) (ZG)

A N E I S

3 x 40W (60W MAX) E 14 230V

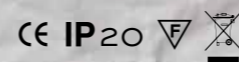

Cod. 6016/5 RA
Cod. 6017/5 **

OPZIONI: (CR) (VB) (VNM) (ZB) (ZG)

A N E I S 5

5 x 40W (60W MAX) E 14 230V

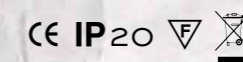

Cod. 6016 RA

Base: Rame
Stelo: Rame
Finitura: Zincatura Gialla (ZG)
Opzioni: codice 6017 Cromo (CR), Verniciatura Bianca (VB), Nera Micacea (VNM), Zincatura Bianca (ZB)
Opzione: codice 6016 Rame (RA)
Particolarità: Steli legati
Lampadina: Colpo di vento
Peso e misure con imballo: 2 kg - 200 x 200 x 660 mm

Base: Copper
Stem: Copper
Finish: Galvanized Yellow (ZG)
Options: code 6017 Chrome (CR), White paint (VB), Black Micaceous (VNM), Galvanized White (ZB)
Option: code 6016 Copper (RA)
Detail: Tied stems
Lamp: Gust of wind
Weight and Measurements including Packaging: 2 kg - 200 x 200 x 660 mm

Base: Cuivre
Tiges: Cuivre
Finition: Zingage Jaune (ZG)
Options: Code 6017 Chrome (CR), Peinture Blanche (VB), Noire Micacé (VNM), Zingage Blanc (ZB)
Option: Code 6016 cuivre (RA)
Particularité: Tiges liées
Ampoule: Coup de vent
Poids et mesures avec emballage: 2 kg - 200 x 200 x 660 mm

Base: Cobre
Tubo: Cobre
Acabado: Galvanizado con Zinc en Amarillo (ZG)
Opciones: código 6017 Cromo (CR), Barnizado Blanco (VB), Negro Micáceo (VNM), Galvanizado con Zinc en Blanco (ZB)
Opciones: código 6016 Cobre (RA)
Particularidades: Tubos atados
Bombilla: Golpe de viento
Peso y medidas con embalaje: 2 kg - 200 x 200 x 660 mm

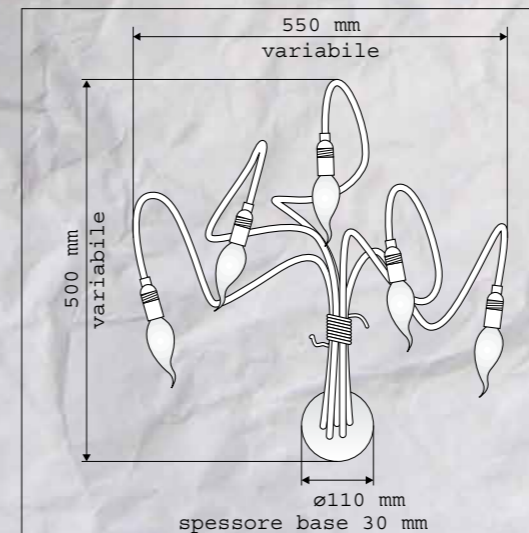
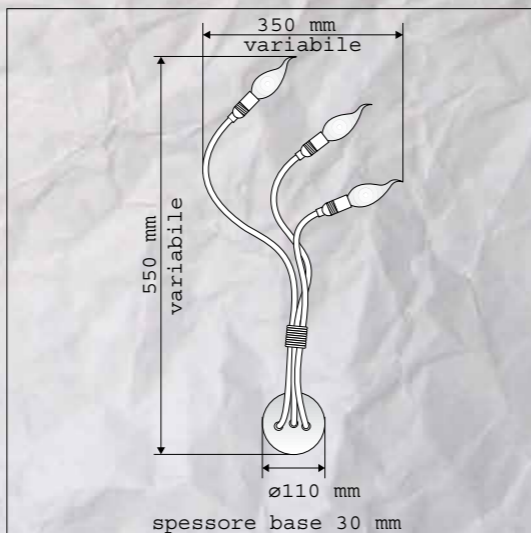

Base: Rame
Stelo: Rame
Finitura: Rame
Opzioni: codice 6017/5 Cromo (CR), Verniciatura Bianca (VB), Nera Micacea (VNM), Zincatura Bianca (ZB) Gialla (ZG)
Particolarità: Steli legati
Lampadina: Colpo di vento
Peso e misure con imballo: 3,7 kg - 750 x 450 x 300 mm
**: Opzione codice

Base: Copper
Stem: Copper
Finish: Copper
Options: code 6017/5 Chrome (CR), White Paint (VB), Black Micaceous (VNM), Galvanized White (ZB), Yellow (ZG)
Detail: Tied stems
Lamp: Gust of wind
Weight and Measurements including Packaging: 3,7 kg - 750 x 450 x 300 mm
**: Code Option

Base: Cuivre
Tiges: Cuivre
Finition: Cuivre
Options: Code 6017/5 Chrome (CR), Peinture Blanche (VB), Noire Micacé (VNM), Zingage Blanc (ZB), Jaune (ZG)
Option: Code 6016 cuivre (RA)
Particularité: Tiges liées
Ampoule: Coup de vent
Poids et mesures avec emballage: 3,7 kg - 750 x 450 x 300 mm
**: Option code



Base: Cobre
Tubo: Cobre
Acabado: Cobre
Opciones: Código 6017/5 Cromo (CR), Barnizado Blanco (VB), Negro Micáceo (VNM), Galvanizado con zinc en Blanco (ZB) Amarillo (ZG)
Particularidades: Tubos atados
Bombilla: Golpe de viento
Peso y medidas con embalaje: 3,7 kg - 750 x 450 x 300 mm
**: Opciones código



Cod. 6018

N O X
1 O x 1 O W MAX
G4 230/1 2V



CE IP20   

Base: Rame
Stelo: Rame
Finitura: Cromo
Particolarità: Lampadine inserite nelle sfere
Trasformatore: Toroidale inserito nella base
Lampadina: Alogena bispina
Peso e misure con imballo: 2,6 kg - 200 x 200 x 660 mm

Base: Copper
Stem: Copper
Finish: Chrome
Detail: Lamps in the spheres
Transformer: Toroidal within the base
Lamp: Double plug-in halogen
Weight and Measurements including Packaging: 2,6 kg - 200 x 200 x 660 mm

Base: Cuivre
Tiges: Cuivre
Finition: Chrome
Particularité: Ampoules insérées dans les sphères
Transformateur: Toroidal inséré dans la base
Ampoule: Halogène bi-pin
Poids et mesures avec emballage: 2,6 kg - 200 x 200 x 660 mm

Base: Cobre
Tubo: Cobre
Acabado: Cromo
Particularidades: Bombillas introducidas en las esferas
Transformador: Toroidal introducido en la base
Bombilla: Halógena doble enchufe
Peso y medidas con embalaje: 2,6 kg - 200 x 200 x 660 mm

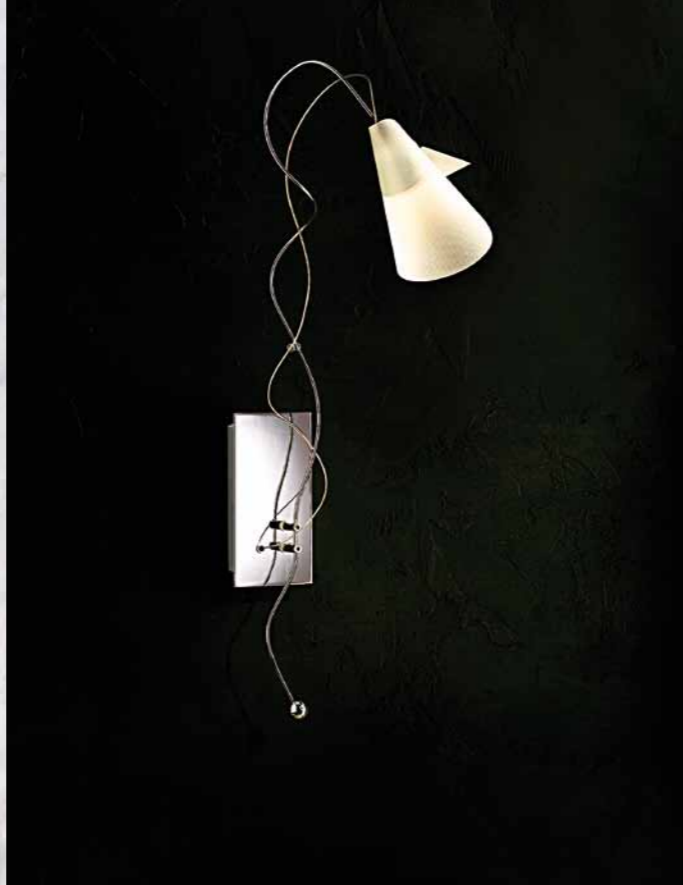

Cod. 6019

F R E A
5 O W MAX Ø5 I
GU5,3 230/1 2V



CE IP20   

Base: Ottone
Stelo: Rame
Finitura: Cromo
Particolarità: Coprilampada in vetro-silicone
Trasformatore: Elettronico inserito nella base
Lampadina: Dicroica
Peso e misure con imballo: 1,6 kg - 200 x 200 x 660 mm

Base: Brass
Stem: Copper
Finish: Chrome
Detail: Silicone-glass lampshade
Transformer: Electronic within the base
Lamp: Dichroic
Weight and Measurements including Packaging: 1,6 kg - 200 x 200 x 660 mm

Base: Laiton
Tiges: Cuivre
Finition: Chrome
Particularité: Abat-jour verre silicone
Transformateur: Électronique inséré dans la base
Ampoule: Dichroïque
Poids et mesures avec emballage: 1,6 kg - 200 x 200 x 660 mm



Base: Latón
Tubo: Cobre
Acabado: Cromo
Particularidades: Cubrelámpara de cristal silicona
Transformador: Electrónico introducido en la base
Bombilla: Dicroica
Peso y medidas con embalaje: 1,6 kg - 200 x 200 x 660 mm



Cod. 6023

T H O R P A R
1 x 75 W MAX
E27 PAR 30 230V



CE IP20   

Base: Ottone
Finitura: Cromo
Particolarità: Versatilità
Lampadina: Par 30
Peso e misure con imballo: 1,3 kg - 290 x 290 x 160 mm

Base: Brass
Finish: Chrome
Detail: Versatility
Lamp: PAR 30
Weight and Measurements including Packaging: 1,3 kg - 290 x 290 x 160 mm

Base: Laiton
Finition: Chrome
Particularité: Éclectisme
Ampoule: Par 30
Poids et mesures avec emballage: 1,3 kg - 290 x 290 x 160 mm

Base: Latón
Acabado: Cromo
Particularidades: Versatilidad
Bombilla: Par 30
Peso y medidas con embalaje: 1,3 kg - 290 x 290 x 160 mm

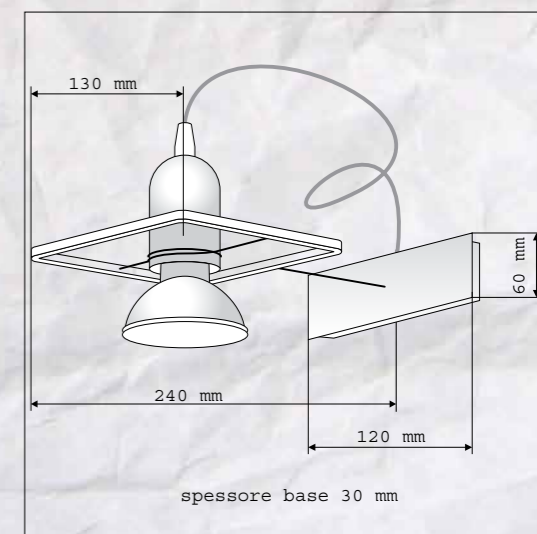
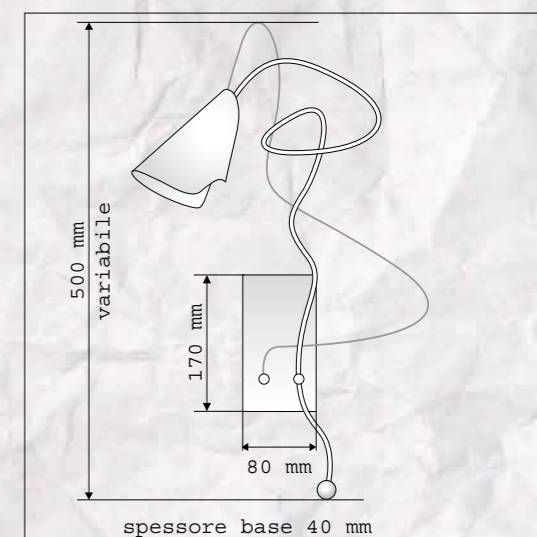
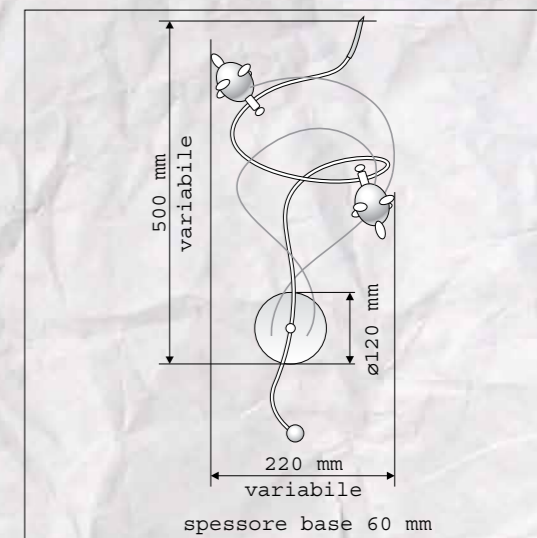



Cod. 6028/3 ZG

OPZIONI: (CR) (VB) (VNM) (ZB)

HALF FAAL

3 x 20W MAX

G4 230/12V



Base: Metallo spazzolato
 Stelo: Rame
 Finitura: Zincatura Gialla (ZG)
 Opzioni: Cromo (CR), Verniciatura Bianca (VB), Nera Micacea (VNM), Zincatura Bianca (ZB)
 Particolarità: Disco centrale in foglia rame e steli modellabili
 Trasformatore: Elettronico inserito nella base
 Lampadina: Alogena bispina
 Peso e misure con imballo: 2,7 kg - 500 x 410 x 250 mm

Base: Brushed metal
 Stem: Copper
 Finish: Yellow galvanized (ZG)
 Options: Chrome (CR), White Paint (VB), Black Micaceous (VNM), Galvanized White (ZB)
 Detail: Copper-foil central disk and mouldable stems
 Transformer: Electronic within the base
 Lamp: Double plug-in halogen
 Weight and Measurements including Packaging: 2,7 kg - 500 x 410 x 250 mm

Base: Métal brossé
 Tiges: Cuivre
 Finition: Zingage Jaune (ZG)
 Options: Chrome (CR), Peinture Blanche (VB), Noire Micacé (VNM), Zingage Blanc (ZB)
 Particularité: Disque central en Feuille de cuivre et tiges modelables
 Transformateur: Électronique inséré dans la base
 Ampoule: Halogène bi-pin
 Poids et mesures avec emballage: 2,7 kg - 500 x 410 x 250 mm

Base: Metal cepillado
 Tubo: Cobre
 Acabado: Galvanizado con Zinc en Amarillo (ZG)
 Opciones: Cromo (CR), Barnizado Blanco (VB), Negro Micáceo (VNM), Galvanizado con zinc en Blanco (ZB)
 Particularidades: Hoja de cobre disco central y tubos moldeables
 Transformador: Electrónico introducido en la base
 Bombilla: Halógena doble enchufe
 Peso y medidas con embalaje: 2,7 kg - 500 x 410 x 250 mm

Cod. 6028/5 CR

OPZIONI (VB) (VNM) (ZB) (ZG)

HALF FAAL 5

5 x 20W MAX

G4 230/12V



Base: Metallo
 Stelo: Rame
 Finitura: Cromo (CR)
 Opzioni: Verniciatura Bianca (VB), Nera Micacea (VNM), Zincatura Bianca (ZB), Gialla (ZG)
 Particolarità: Disco centrale cromato e steli modellabili
 Trasformatore: Elettronico inserito nella base
 Lampadina: Alogena bispina
 Peso e misure con imballo: 3,6 kg - 250 x 410 x 500 mm

Base: Metal
 Stem: Copper
 Finish: Chrome (CR)
 Options: White Paint (VB), Black Micaceous (VNM), Galvanized White (ZB), Yellow (ZG)
 Detail: Chrome central disk and mouldable stems
 Transformer: Electronic within the base
 Lamp: Double plug-in halogen
 Weight and Measurements including Packaging: 3,6 kg - 250 x 410 x 500 mm

Base: Métal
 Tiges: Cuivre
 Finition: Chrome (CR)
 Options: Peinte Blanc (VB), Noire Micacé (VNM), Zingage Blanc (ZB), Jaune (ZG)
 Particularité: Feuille de cuivre disque central et tiges modelables
 Transformateur: Électronique inséré dans la base
 Ampoule: Halogène bi-pin
 Poids et mesures avec emballage: 3,6 kg - 250 x 410 x 500 mm

Base: Metal
 Tubo: Cobre
 Acabado: Cromo (CR)
 Opciones: Barnizada Blanco (VB), Negro Micáceo (VNM), Galvanizado con Zinc en Blanco (ZB), Amarillo (ZG)
 Particularidades: Hoja de cobre disco central y tubos moldeables
 Transformador: Electrónico introducido en la base
 Bombilla: Halógena doble enchufe
 Peso y medidas con embalaje: 3,6 kg - 250 x 410 x 500 mm

Cod. 6028/5 VB

OPZIONI (CR) (VNM) (ZB) (ZG)

HALF FAAL 5

5 x 20W MAX

G4 230/12V

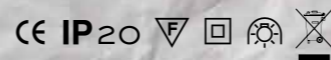

Base: Metallo
 Stelo: Rame
 Finitura: Verniciatura Bianca (VB),
 Opzioni: Cromo (CR), Verniciatura Nera Micacea (VNM), Zincatura Bianca (ZB), Gialla (ZG)
 Particolarità: Disco centrale in foglia rame e steli modellabili
 Trasformatore: Elettronico inserito nella base
 Lampadina: Alogena bispina
 Peso e misure con imballo: 3,6 kg - 250 x 410 x 500 mm

Base: Metal
 Stem: Copper
 Finish: White Paint (VB)
 Options: Chrome (CR), Black Paint (VNM), Galvanized White (ZB), Yellow (ZG)
 Detail: Copper-foil, central disk and mouldable stems
 Transformer: Electronic within the base
 Lamp: Double plug-in halogen
 Weight and Measurements including Packaging: 3,6 kg - 250 x 410 x 500 mm

Base: Métal
 Tiges: Cuivre
 Finition: Peinte Blanc (VB)
 Options: Chrome (CR), Peinture Noire (VNM), Zingage Blanc (ZB), Jaune (ZG)
 Particularité: Feuille de cuivre disque central et tiges modelables
 Transformateur: Électronique inséré dans la base
 Ampoule: Halogène bi-pin
 Poids et mesures avec emballage: 3,6 kg - 250 x 410 x 500 mm

Base: Metal
 Tubo: Cobre
 Acabado: Barnizada Blanco (VB)
 Opciones: Cromo (CR), Barnizado Negro (VNM), Galvanizado con Zinc en Blanco (ZB) Amarillo (ZG)
 Particularidades: Hoja de cobre disco central y tubos moldeables
 Transformador: Electrónico introducido en la base
 Bombilla: Halógena doble enchufe
 Peso y medidas con embalaje: 3,6 kg - 250 x 410 x 500 mm

Per gli articoli:

Cod. 6028/3 ZB

Cod. 6028/5 ZB

Disco Centrale Foglia Argento
 Silver Foil Central Disk
 Feuille de Argent Disque Central
 Hoja de Plata Disco Central

Cod. 6028/3 VNM

Cod. 6028/5 VNM

Disco Centrale Foglia Argento
 Silver Foil Central Disk
 Feuille de Argent Disque Central
 Hoja de Plata Disco Central

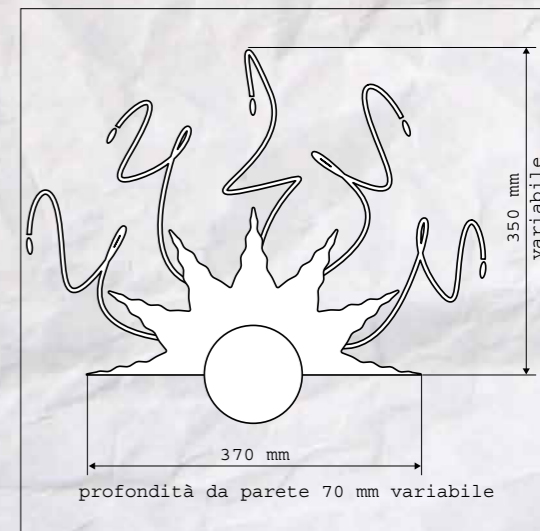
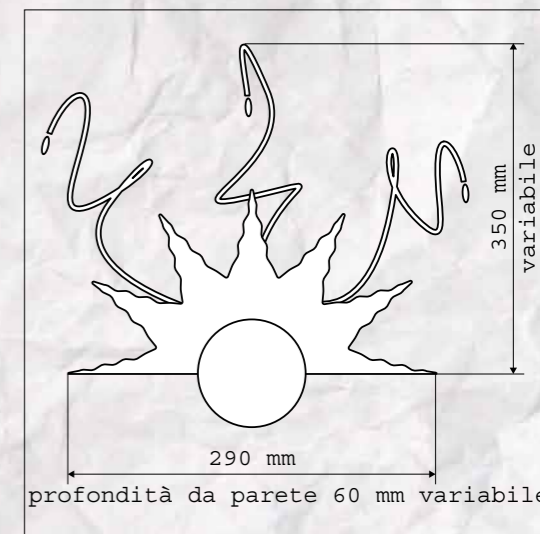

LUCIFERO A NEW YORK

Brooklyn Museum - New York

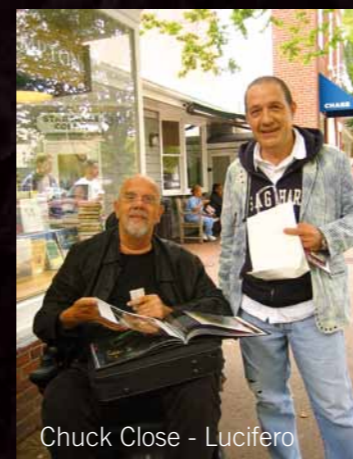

Chuck Close - Lucifero

LUCIFERO SEDUCE LA GRANDE MELA

Da Torino alla Grande Mela. Le mille tentazioni di Lucifero conquistano New York e se è difficile resistere al fascino misterioso di un Lucifero mitologico, come faranno i newyorkesi a non farsi incantare da mille forme di luce, originali e accattivanti? Per la prima volta, è il museo di arte contemporanea di Brooklyn, in occasione del BIFF (Brooklyn International Film Festival), ad ospitare la collezione 2007 di Lucifero: d'ora in poi non stupiamoci se tra i strabilianti luccichii di Brooklyn, Manhattan, Central Park anche Lucifero avrà la sua parte.

LUCIFERO SEDUCES THE BIG APPLE.

From the city of Torino to the Big Apple. Lucifero's thousand temptations have conquered New York City and even if it is difficult to resist the mysterious charm of the mythological Lucifer, how will New Yorkers be unable to be enchanted by the thousand light shapes, so original and captivating? For the first time, the Contemporary Art Museum in Brooklyn, in occasion of the Brooklyn International Film Festival, gave hospitality to the 2007 Lucifero collection: from now on we won't be surprised if among the dazzling lights of Brooklyn, Manhattan and Central Park, Lucifero has his say.



Casa Privata
Private House



Casa Privata
Private House



Casa Privata
Private House



Studio Privato
Private Studio



Casa Privata
Private House

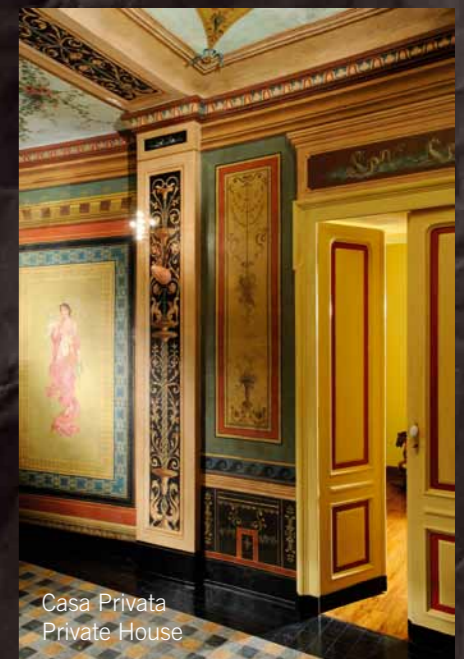

Casa Privata
Private House



Casa Privata
Private House



Casa Privata
Private House



Casa Privata
Private House





Theatre Politeama - Bra (CN) - Italy



Fuori Catalogo / Out of Catalogue

Lampadari 48 luci in rame zincato giallo, ø 3000 mm
Chandeliers - 48 lights in copper yellow galvanized, ø 3000 mm



Arch. Genta

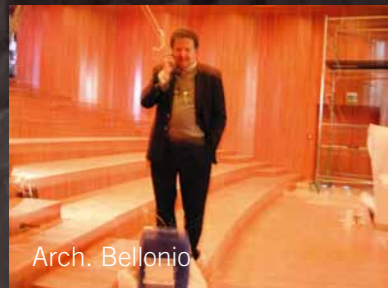

Arch. Bellonio

Gli architetti Genta e Bellonio, progettisti del teatro di Bra, durante una pausa relax.

The Designers of the Bra Theatre, Architects Genta and Bellonio taking a break.

Lampadario fuori catalogo costituito da 4 strutture indipendenti con possibilità di configurare sospensioni a diverse altezze.

Bespoke chandelier with 4 independent structures with the possibility to hang at different heights.

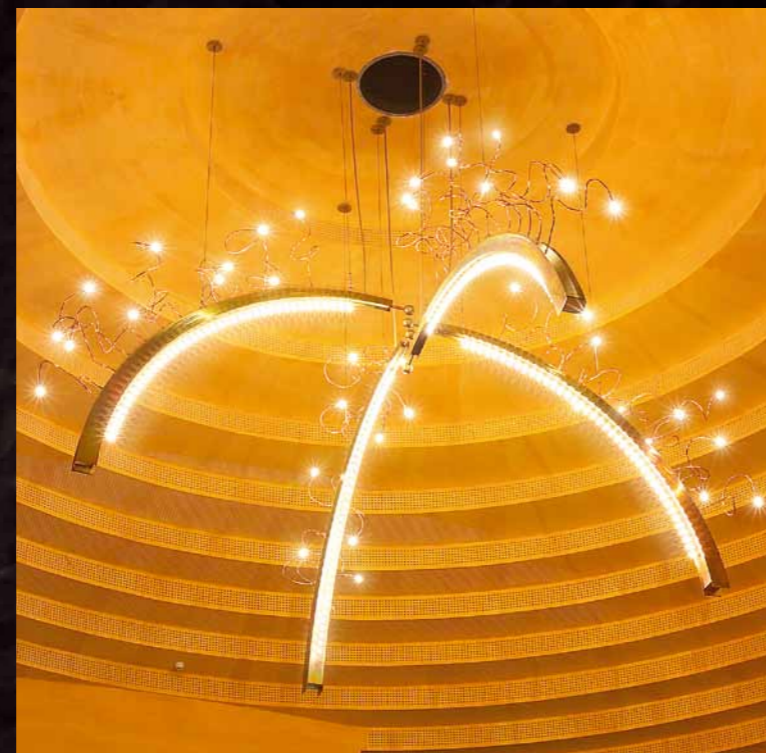

Lampadario fuori catalogo
eseguito per il Teatro sociale della città di Alba - CN

Bespoke chandelier
created for the "Teatro Sociale della Città di Alba" - (CN) - Italy



Villa Tiboldi



Istituto Culturale Italiano di Copenaghen
Italian Cultural Institute of Copenaghen





L'arte è la massima espressione creativa e concettuale dell'uomo, egli lascia ai posteri testimonianza del proprio tempo e del proprio pensiero...

Lucifero con la luce testimonia la loro grandezza facendo omaggio a Salvador Dalì, Keith Haring, Marilyn Monroe, Antonio De Curtis e Andy Warhol.

Art is the best creative expression and conceptual tool belonging to man, it leaves to posterity testament of its own time and thought...

Lucifero through light pays homage to the greatness of Salvador Dalì, Keith Haring, Marilyn Monroe, Antonio De Curtis and Andy Warhol.

L'art est la plus grande expression créative et conceptuelle de l'homme, il transmet à la postérité le témoignage de son temps et de sa pensée...

Lucifero avec la lumière témoigne de leur grandeur rendant hommage à Salvador Dalì, Keith Haring, Marilyn Monroe, Antonio De Curtis et Andy Warhol

El arte es la máxima expresión creativa y conceptual del hombre, él deja testimoniancia a la posteridad del propio tiempo y del propio pensamiento...

Lucifero con la luz da testimonio de su grandezza homenajeando a Salvador Dalì, Keith Haring, Marilyn Monroe, Antonio De Curtis e Andy Warhol.





ANTONIO DE CURTIS



SALVADOR DALÍ



MARILYN MONROE



KEITH HARING



ANDY WARHOL



È nei nostri momenti più bui che dobbiamo concentrarci per vedere la luce

Aristotele Onassis

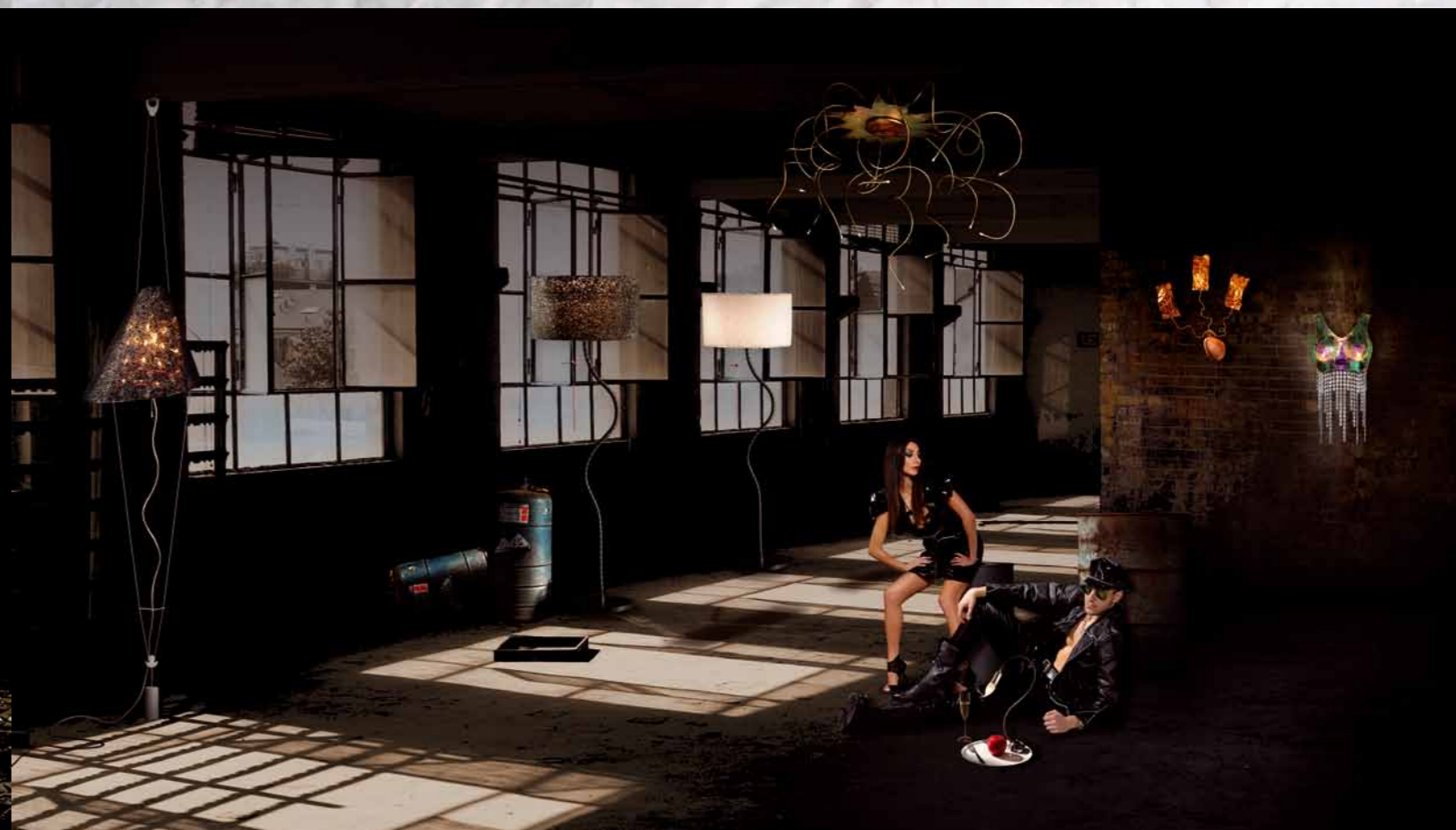

TRYSPO
RAKKUS WHITE
ANELS 5
EXIT
FLORA

NAXAC, ASHIK
FAAL, CAYP
SOTTO IL
VESTITO WALL
FRUTTO DEL
PECCATO



Cod. 7015 N

A S H I K

1 50W MAX E27

HEG 220-240V



Base: Metallo Verniciato Nero Micaceo (VNM)

Paralume: Quash

Opzione: cod. 7015 B

Stelo: In rame all'interno di tubo in gomma, rivestito in tessuto

Particolarità: Stelo modellabile

Lampadina : Alogena

Peso e misure con imballo: 17 kg - 1.910 x 720 x 720 mm

Base: Black Painted Micaceous Metal

Shade: Quash

Options: Code 7015 B

Stem: Copper in a rubber tube, outer covering in fabric

Detail: Malleable stem

Bulb: Halogen

Weight and Measurements including Packaging: 17 kg - 1.910 x 720 x 720 mm

Socle: Métal Peint Noir Micacé

Abat-jour: Quash

Option: Code 7015 B

Tige: En cuivre à l'intérieur d'un tube en caoutchouc, revêtu de tissu

Particularité: Tige modelable

Ampoule: Halogène

Poids et mesures avec emballage: 17 kg - 1.910 x 720 x 720 mm

Base: Metal Barnizado Negro Micáceo

Pantalla: Quash

Opciones: Cód. 7015 B

Tubo: De cobre en el interior del tubo de goma, recubierto de tejido.

Particularidades: Tubo moldeable

Bombilla: Halógena

Peso y medidas con embalaje: 17 kg - 1.910 x 720 x 720 mm



Cod. 7015 B

A S H I K

1 50W MAX E27

HEG 220-240V

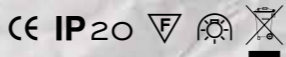

Base: Metallo Verniciato Nero Micaceo (VNM)

Paralume: Quash

Opzione: Cod. 7015 N

Stelo: In rame all'interno di tubo in gomma, rivestito in tessuto

Particolarità: Stelo modellabile

Lampadina : Alogena

Peso e misure con imballo: 17 kg - 1.910 x 720 x 720 mm

Base: Black Painted Micaceous Metal

Shade: Quash

Options: Code 7015 N

Stem: Copper in a rubber tube, outer covering in fabric

Detail: Malleable stem

Bulb: Halogen

Weight and Measurements including Packaging: 17 kg - 1.910 x 720 x 720 mm

Socle: Métal Peint Noir Micacé

Abat-jour: Quash

Option: Code 7015 N

Tige: En cuivre à l'intérieur d'un tube en caoutchouc, revêtu de tissu

Particularité: Tige modelable

Ampoule: Halogène

Poids et mesures avec emballage: 17 kg - 1.910 x 720 x 720 mm

Base: Metal Barnizado Negro Micáceo

Pantalla: Quash

Opciones: Cód. 7015 N

Tubo: De cobre en el interior del tubo de goma, recubierto de tejido.

Particularidades: Tubo moldeable

Bombilla: Halógena

Peso y medidas con embalaje: 17 kg - 1.910 x 720 x 720 mm



Cod. 7014 B

Cod. 7014 N

N A X A C

1 x 1 50W MAX E27

HEG 220-240V

TOUCH CONTROL

LED RGB 7,2W 24V DC

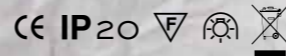

Accessori: Metallo verniciato grigio

Paralume: In policarbonato con effetto multi lente

Cover: In tessuto Bianco (cod. 7014 B) Nero (cod. 7014 N)

Particolarità: Lampada saliscendi, il LED RGB all'interno del paralume è touch. In dotazione 7 mt. di cavo in acciaio

Lampadina: Alogena

Peso e misure con imballo: 6,5 kg - 750 x 450 x 300 mm

Accessories: Grey painted metal

Shade: Polycarbonate with multi lens effect

Cover: White fabric (code 7014B) Black (code 7014N)

Detail: Rise and fall lamp led rgb with touch switch inside the shade. 7mt of steel cable supplied.

Bulb: Halogen

Weight and Measurements including Packaging: 6,5 kg - 750 x 450 x 300 mm

Accessoires: Métal peint gris

Abat-jour: En polycarbonate avec effet grossissant

Revêtement: En tissu blanc (code 7014 B) Noir (code 7014 N)

Particularité: lampe réglable en hauteur LED RGB avec variateur d'intensité à l'intérieur de l'abat-jour. En dotation 7m de câble acier inox.

Ampoule: Halogène

Poids et mesures avec emballage: 6,5 kg - 750 x 450 x 300 mm

Accesorios: Metal Barnizado gris

Pantalla: De policarbonato con efecto multi-lente

Cover: De tejido Blanco (cód. 7014 B) Negro (cód. 7014 N)

Particularidades: Bombilla sube-baja led rgb en el interior de la pantalla è touch. En dotación 7 mt. de cable de acero inox.

Bombilla: Halógena

Peso y medidas con embalaje: 6,5 kg - 750 x 450 x 300 mm

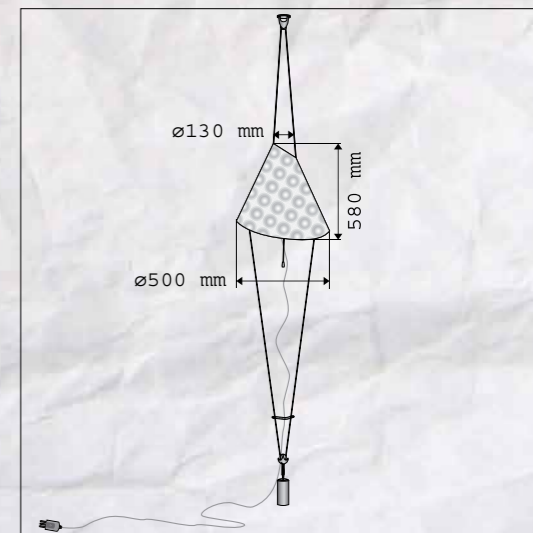
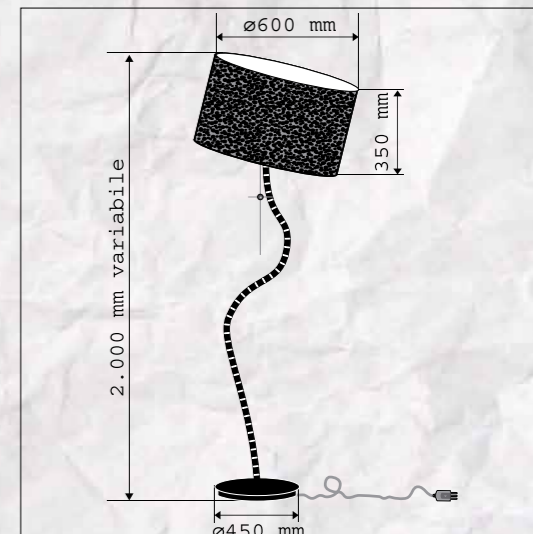



Cod. 7003

OPZIONI: (CR) (VB) (VNM) (ZB) (ZG)

TRIBAL

3 x 40W (60W MAX)
E14 230V

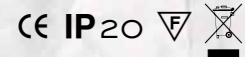

Base: Rame
Stelo: Rame
Finitura: Rame (RA)
Opzioni: Cromata (CR), Verniciatura Bianca (VB), Nera Micacea (VNM), Zincatura Bianca (ZB), Gialla (ZG)
Particolarità: Steli legati
Lampadina: Colpo di vento
Peso e misure con imballo: 9,5 kg - 360 x 300 x 2.150 mm
Opzione: Con più steli (max 9)

Base: Copper
Stem: Copper
Finish: Copper
Options: Chrome (CR), White Paint (VB), Black Micaceous (VNM), Galvanized White (ZB) Yellow (ZG)
Detail: tied stems
Lamp: Gust of wind
Weight and Measurements including Packaging: 9,5 kg - 360 x 300 x 2.150 mm
Option: With more stems (9 max)

Socle: Cuivre
Tiges: Cuivre
Finition: Cuivre (RA)
Options: Chromée (CR), Peinture Blanche (VB), Noire Micacé (VNM), Zingage Blanc (ZB), Jaune (ZG)
Particularité: Tiges liées
Ampoule: Coup de vent
Poids et mesures avec emballage: 9,5 kg - 360 x 300 x 2.150 mm
Option: Avec plusieurs tiges (max 9)

Base: Cobre
Tubo: Cobre
Acabado: Cobre (RA)
Opciones: Cromada (CR), Barnizado Blanco (VB), Negro Micáceo (VNM), Galvanizado con Zinc en Blanco (ZB), Amarillo (ZG)
Particularidades: Tubos atados
Bombilla: Golpe de viento
Peso y medidas con embalaje: 9,5 kg - 360 x 300 x 2.150 mm
Opciones: Con más tubos (máx 9)



Cod. 7008 CR

OPZIONI: (RA) (VB) (VNM) (ZB) (ZG)

VILLA RIVOLI

12 x 40W MAX
E14 230V

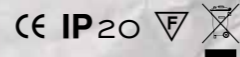

Base: Metallo zincato
Stelo: Rame
Finitura: Cromo (CR)
Opzioni: Rame (RA), Verniciatura Bianca (VB), Nera Micacea (VNM), Zincatura Bianca (ZB), Gialla (ZG)
Particolarità: Foglia argento sulla base solo nella versione Cromo (CR)
Lampadina: Colpo di vento
Peso e misure con imballo: 19 kg - 570 x 550 x 2.300 mm

Base: Galvanized metal
Stem: Copper
Finish: Chrome
Options: Copper (RA), White Paint (VB), Black Micaceous (VNM), Galvanized White (ZB), Yellow (ZG)
Detail: Silver leaf on base only on Chrome (CR) version
Lamp: Gust of wind
Weight and Measurements including Packaging: 19 kg - 570 x 550 x 2.300 mm

Socle: Métal zingué
Tiges: Cuivre
Finition: Chrome (CR)
Options: Cuivre (RA), Peinture Blanche (VB), Noire Micacé (VNM), Zingage Blanc (ZB), Jaune (ZG)
Particularité: Feuille argent sur le socle pour la version Chrome (CR) seulement
Ampoule: Coup de vent
Poids et mesures avec emballage: 19 kg - 570 x 550 x 2.300 mm

Base: Metal Galvanizado con Zinc
Tubo: Cobre
Acabado: Cromo (CR)
Opciones: Cobre (RA), Barnizado Blanco (VB), Negro Micáceo (VNM), Galvanizado con zinc en Blanco (ZB), Amarillo (ZG)
Particularidades: Hoja de plata en la base sólo en la versión Cromo (CR)
Bombilla: Golpe de viento
Peso y medidas con embalaje: 19 kg - 570 x 550 x 2.300 mm



Cod. 7009

OPZIONI: (CR) (ZB) (ZG)

G R A A

12 x 20W MAX
G4 230/12V

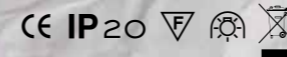

Base: Rame
Stelo: Rame
Finitura: Rame (RA)
Opzioni: Cromata (CR), Zincatura Bianca (ZB), Gialla (ZG)
Particolarità: Steli piegati e legati
Trasformatore: Toroidale inserito nella base
Lampadina: Alogena Bispina
Peso e misure con imballo: 17,2 kg - 360 x 300 x 2.150 mm

Base: Copper
Stem: Copper
Finish: Copper
Options: Chrome (CR), Galvanized White (ZB), Yellow (ZG)
Detail: Tied and bent stems
Transformer: Toroidal within the base
Lamp: Double plug-in halogen
Weight and Measurements including Packaging: 17,2 kg - 360 x 300 x 2.150 mm

Socle: Cuivre
Tiges: Cuivre
Finition: Cuivre (RA)
Options: Chromée, Zingagée Blanc (ZB), Jaune (ZG)
Particularité: Tiges pliées et liées
Transformateur: Toroidal inséré dans le socle
Ampoule: Halogène bi-pin
Poids et mesures avec emballage: 17,2 kg - 360 x 300 x 2.150 mm

Base: Cobre
Tubo: Cobre
Acabado: Cobre (RA)
Opciones: Cromada (CR), Galvanizada con Zinc en Blanco (ZB) y Amarillo (ZG)
Particularidades: Tubos doblados y atados
Transformador: Toroidal introducido en la base
Bombilla: Halógena doble enchufe
Peso y medidas con embalaje: 17,2 kg - 360 x 300 x 2.150 mm

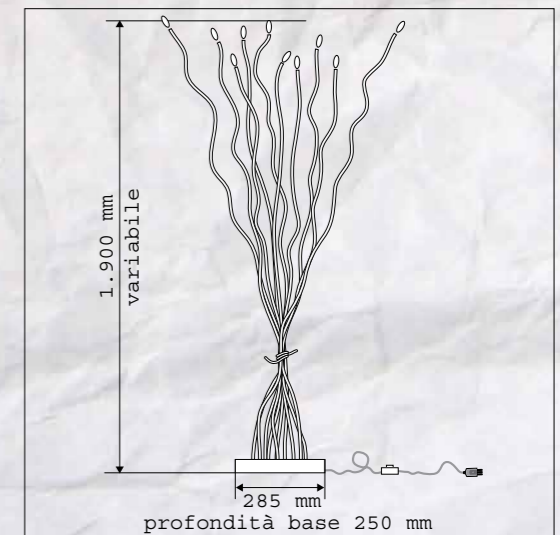
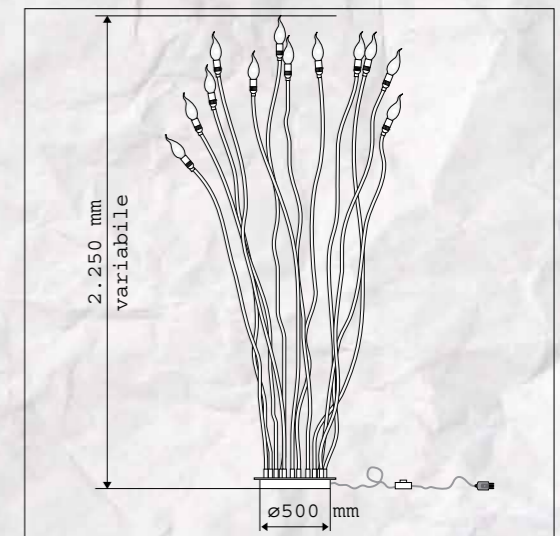
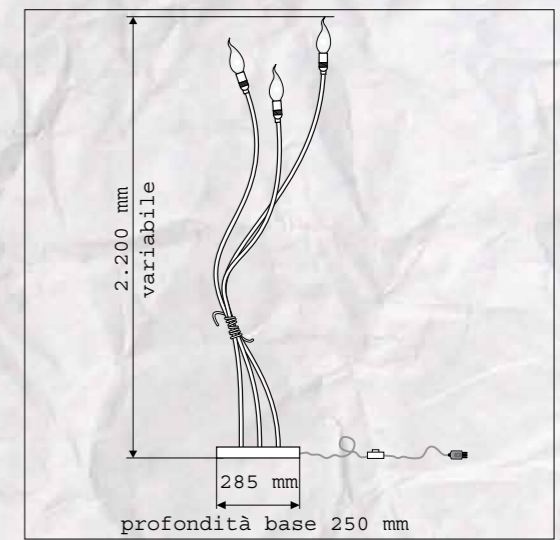



Cod. 7010

SOTTO IL VESTITO NIENTE

7 x 20W MAX

G4 230/12V



Base: Metallo spazzolato
 Stelo: Rame
 Finitura: Cromo (CR)
 Particolarità: Busto trattato con speciali pellicole iridescenti e finitura siliconica, Pendenti in cristallo
 Trasformatore: Toroidale inserito nella base
 Lampadina: Alogena bispina
 Peso e misure con imballo: 13 Kg - 360 x 470 x 2.150 mm

Base: Brushed metal
 Stem: Copper
 Finish: Chrome (CR)
 Detail: Bust coated with unique iridescent films and silicone coating, Chrystal Pendants
 Transformer: Toroidal transformer within the base
 Lamp: Double plug-in halogen
 Weight and Measurements including Packaging: 13 Kg - 360 x 470 x 2.150 mm

Socle: Métal brossé
 Tiges: Cuivre
 Finition: Chrome (CR)
 Particularité: Buste traité avec des films iridescents particuliers et finition siliconée, Pendants en cristal
 Transformateur: Toroidal inséré dans le socle
 Ampoule: Halogène bi-pin
 Poids et mesures avec emballage: 13 Kg - 360 x 470 x 2.150 mm

Base: Metal cepillado
 Tubo: Cobre
 Acabado: Cromo (CR)
 Particularidades: Busto tratado con especiales películas iridescentes y acabado con silicona, Colgantes de cristal
 Transformador: Toroidal introducido en la base
 Bombilla: Halógena doble enchufe
 Peso y medidas con embalaje: 13 Kg - 360 x 470 x 2.150 mm



Cod. 7011

B A A R A S

15 x 20W MAX Ø35

G4 230/12V

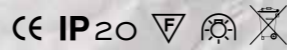

Base: Metallo
 Stelo: Rame
 Finitura: Steli zincati bianchi, base verniciata grigia
 Particolarità: Copertura lampade in vetro silicico - Uccellino su uno stelo
 Trasformatori: n. 3 Elettronici inseriti nel fusto
 Lampadina: Dicroica
 Peso e misure con imballo: 18 kg - 300 x 360 x 2.150 mm

Base: Metal
 Stem: Copper
 Finish: Galvanized white stems, grey paint base
 Detail: Silicone-glass lampshade - little bird on a stem
 Transformer: no. 3 Electronic transformers within the base
 Lamp: Dichroic
 Weight and Measurements including Packaging: 18 kg - 300 x 360 x 2.150 mm

Socle: Métal
 Tiges: Cuivre
 Finition: Tiges Zingués Blancs, socle peint gris
 Particularité: Couverture des lampes en verre silicóné - oiseau sur une tige
 Transformateurs: 3 Electronique insérés dans le socle
 Ampoule: Dichroïque
 Poids et mesures avec emballage: 18 kg - 300 x 360 x 2.150 mm

Base: Metal
 Tubo: Cobre
 Acabado: Tubos Galvanizados con Zinc en Blanco, base barnizada gris
 Particularidades: Cubrelámparas de cristal silicona - Pajarillo en un tubo
 Transformador: n. 3 Electrónico introducidos en la base
 Bombilla: Dicroica
 Peso y medidas con embalaje: 18 kg - 300 x 360 x 2.150 mm



Cod. 7019 ZB

OPZIONI: (CR) (VNM) (ZG)

T R Y S P O T

3 x 75W MAX QR III

G53 230/12V

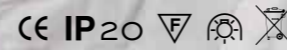

Base: Rame
 Stelo: Rame
 Finitura: Zincata Bianca (ZB)
 Opzioni: Cromata (CR), Veriniciatura Nera Micacea (VNM), Zincatura Gialla (ZG)
 Particolarità: Steli piegati e legati
 Trasformatore: Toroidale inserito nella base
 Lampadina: Halospot
 Peso e misure con imballo: 11 kg - 360 x 300 x 2.150 mm

Base: Copper
 Stem: Copper
 Finish: White Galvanized (ZB)
 Options: Chrome (CR), Black Paint Micaceous (VNM), Yellow Galvanized (ZG)
 Detail: Tied and bent stems
 Transformer: Toroidal within the base
 Lamp: Double plug-in halogen
 Weight and Measurements including Packaging: 11 kg - 360 x 300 x 2.150 mm

Socle: Cuivre
 Tiges: Cuivre
 Finition: Zingagée Blanc (ZB)
 Options: Chromée, Verni Noir Micacé (VNM), Zingagée Jaune (ZG),
 Particularité: Tiges pliées et liées
 Transformateur: Toroidal inséré dans le socle
 Ampoule: Halogène bi-pin
 Poids et mesures avec emballage: 11 kg - 360 x 300 x 2.150 mm

Base: Cobre
 Tubo: Cobre
 Acabado: Galvanizada con Zinc en Blanco (ZB)
 Opciones: Cromada (CR), Barnizado Negro Micáceo (VNM), Galvanizada con Zinc en Amarillo (ZG)
 Particularidades: Tubos doblados y atados
 Transformador: Toroidal introducido en la base
 Bombilla: Halógena doble enchufe
 Peso y medidas con embalaje: 11 kg - 360 x 300 x 2.150 mm

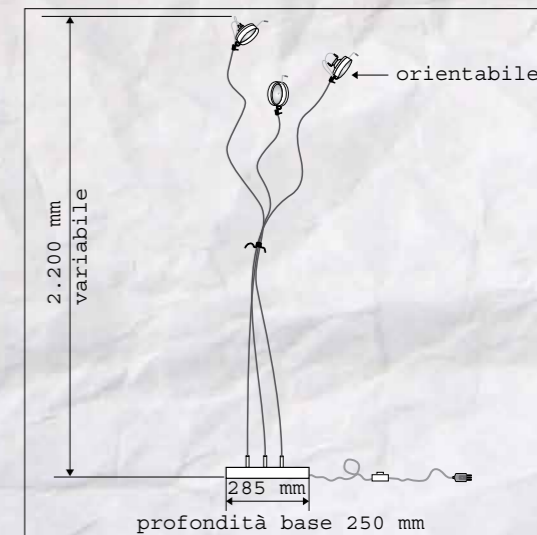
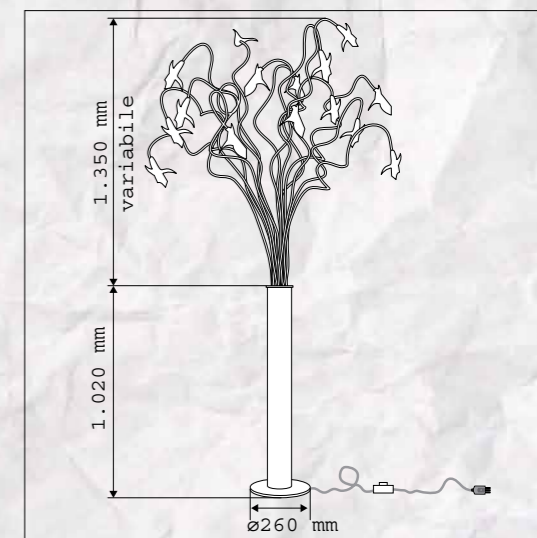
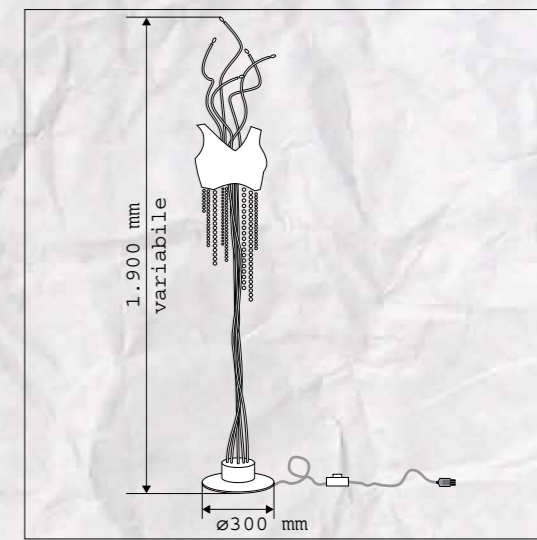



LEO BURNETT
sistema fuori catalogo per illuminare la scala del palazzo storico

LEO BURNETT
Bespoke lighting system for the staircase of a historical mansion.



Cantine Cavagnero - La Morra - Cuneo
Modello Tribal versione parete

Cavagnero wine-producer La Morra - Cuneo
Tribal model wall version



Applique - Versione speciale fuori catalogo
Applique - Bespoke Special Version



Casa Privata
Private House



Casa Privata
Private House



Casa Privata
Private House



Casa Privata
Private House



Casa Privata
Private House



Casa Privata
Private House

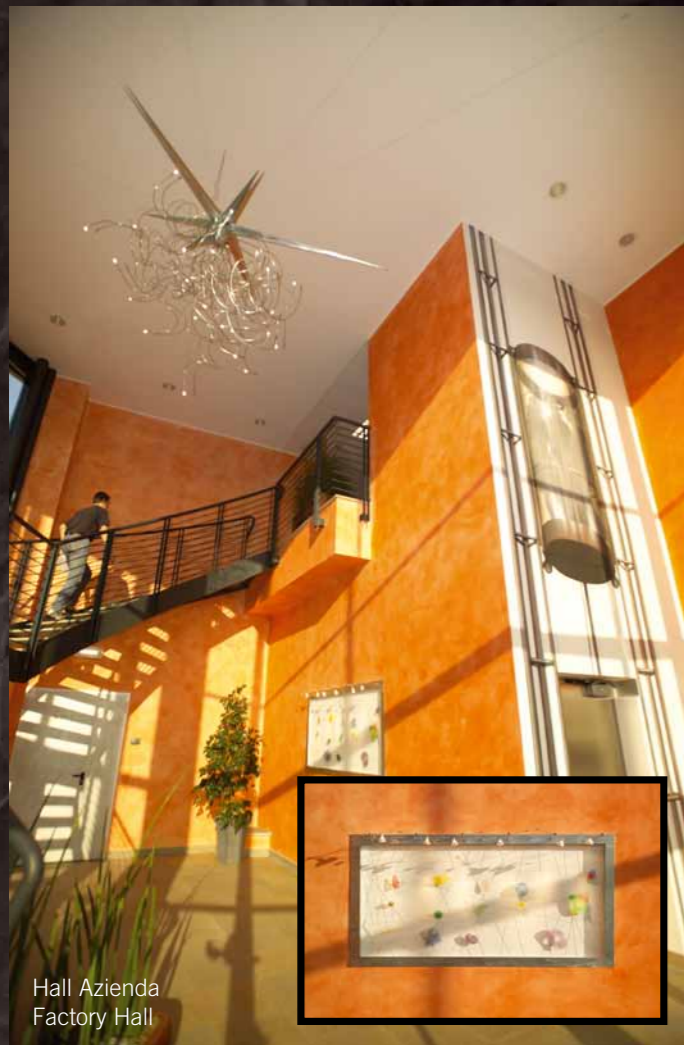

Hall Azienda
Factory Hall



Un creativo Studio Legale
A creative Law Firm



Centro Estetico
Beauty Center



CIPPONET - Un forno creativo
CIPPONET - Creative restaurant



Comunicabolo - Studio Fotografico
Comunicabolo - Photograph Studio



Casa Privata
Private House



Il "Portico" - San Giorgio Canavese (TO)



Casa Privata
Private House





Cod. 7533 CR
Cod. 7533 RA
C A Y S
 1 2x20W MAX G4 1 2V
 220-240/1 2V



Base: Rame
 Ogiva: Rame
 Finitura: Cromo (CR)
 Opzioni: Base e ogiva in rame cod. 7533 RA
 Particolarità: Steli in rame isolato e fogli in alluminio ramato da un lato
 Trasformatori: Elettronici inseriti nell'ogiva
 Lampadina: Alogena bispina
 Peso e misure con imballo: 5 kg - 750 x 450 x 300 mm

Base: Copper
 Point: Copper
 Finish: Chrome
 Options: Base and point in copper code 7533 RA
 Detail: Insulated copper stems and aluminium leaves on one side
 Transfrmer: Electronic within the point
 Bulb: Double plug-in halogen
 Weight and Measurements including Packaging: 5 kg - 750 x 450 x 300 mm

Base: Cuivre
 Ogive: Cuivre
 Finition: Chrome
 Option: Base et ogive en cuivre code 7533 RA
 Particularité: Tiges en cuivre isolé et feuilles en aluminium cuivré d'un côté
 Transformateur: Électronique inséré dans la ogive
 Ampoule: Halogène bi-pin
 Poids et mesures avec emballage: 5 kg - 750 x 450 x 300 mm

Base: Cobre
 Ojiva: Cobre
 Acabado: Cromo
 Opciones: Base y ojiva de cobre cód. 7533 RA
 Particularidades: Tubos de cobre aislado y folios de aluminio cobrizo por un lado.
 Transformador: Electrónico introducido en la ojiva Bombilla: Halógena doble enchufe
 Peso y medidas con embalaje: 5 kg - 750 x 450 x 300 mm



Cod. 7522 white
RAKKUS
 3 x 75W MAX
 E27 230V

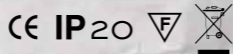

Base: Metallo
 Finitura: Cromo
 Braccio: Resina verniciato cromo
 Particolarità: Paralume in resina nera o naturale
 Lampadina: Goccia E27
 Peso e misure con imballo: 10,5 kg - 800 x 530 x 800 mm

Base: Metal
 Finish: Chrome
 Arm: Painted resin chrome
 Detail: Lamp shade available in black or natural shade resin
 Bulb: E27 light bulb
 Weight and Measurements including Packaging: 10,5 kg - 800 x 530 x 800 mm

Base: Métal
 Finition: Chrome
 Bras: Résine peinte chrome
 Particularité: Abat-jour en résine noire ou naturelle
 Ampoule: Goutte E27
 Poids et mesures avec emballage: 10,5 kg - 800 x 530 x 800 mm

Base: Metal
 Acabado: Cromo
 Brazo: Resina barnizada cromo
 Particularidades: Pantalla de resina negra o natural
 Bombilla: Gota E27
 Peso y medidas con embalaje: 10,5 kg - 800 x 530 x 800 mm



Cod. 7523 black
RAKKUS
 3 x 75W MAX
 E27 230V

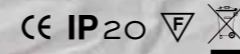

Base: Metallo
 Finitura: Cromo
 Braccio: Resina verniciato cromo
 Particolarità: Paralume in resina nera o naturale
 Lampadina: Goccia E27
 Peso e misure con imballo: 10,5 kg - 800 x 530 x 800 mm

Base: Metal
 Finish: Chrome
 Arm: Painted resin chrome
 Detail: Lamp shade available in black or natural shade resin
 Bulb: E27 light bulb
 Weight and Measurements including Packaging: 10,5 kg - 800 x 530 x 800 mm

Base: Métal
 Finition: Chrome
 Bras: Résine peinte chrome
 Particularité: Abat-jour en résine noire ou naturelle
 Ampoule: Goutte E27
 Poids et mesures avec emballage: 10,5 kg - 800 x 530 x 800 mm

Base: Metal
 Acabado: Cromo
 Brazo: Resina barnizada cromo
 Particularidades: Pantalla de resina negra o natural
 Bombilla: Gota E27
 Peso y medidas con embalaje: 10,5 kg - 800 x 530 x 800 mm

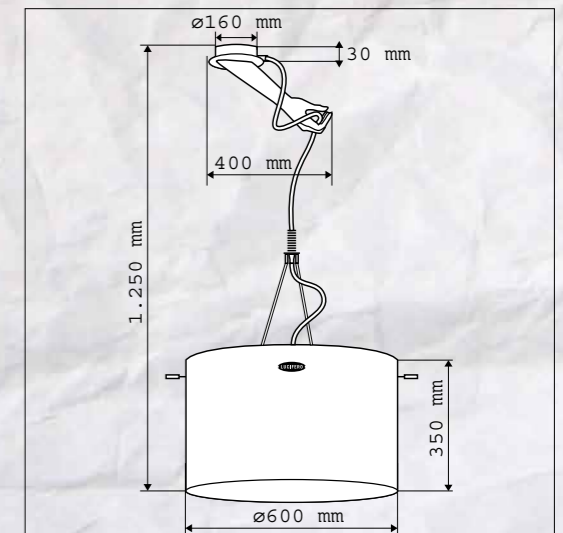
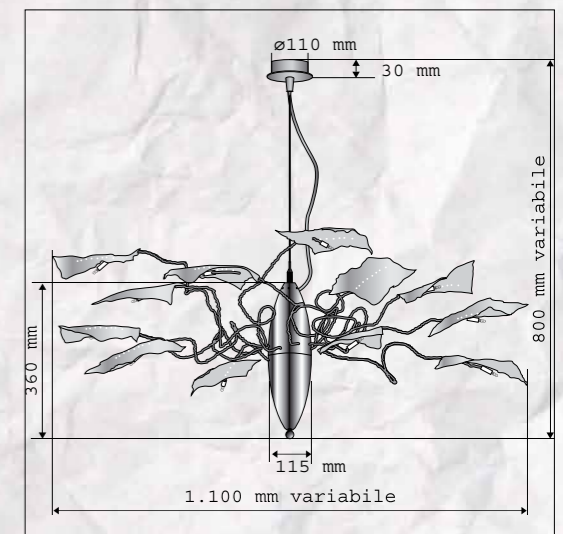





Cod. 7524

BATHIM
2 x 60W MAX
G9 230V



CE IP20   

Base: Rame
Stelo: Cromato
Finitura: Cromo
Particolarità: Tessuto Metallico e pendenti in cristallo
Lampadina: Alogena
Peso e misure con imballo: 3,5 kg - 460 x 120 x 1.130 mm

Base: Copper
Stem: Chrome
Finish: Chrome
Detail: Metallic net fabric and crystal pendants
Lamp: Halogen
Weight and Measurements including Packaging: 3,5 kg - 460 x 120 x 1.130 mm

Base: Cuivre
Tiges: Cromé
Finition: Chrome
Particolarité: Tissu métallique et pendants en cristal
Ampoule: Halogène
Poids et mesures avec emballage: 3,5 kg - 460 x 120 x 1.130 mm



Base: Cobre
Tubo: Cromo
Acabado: Cromo
Particularidades: Tejido Metálico y colgantes de cristal
Bombilla: Halógena
Peso y medidas con embalaje: 3,5 kg - 450 x 120 x 1.130 mm



Cod. 7529 CR

OPZIONI: (RA) (ZB) (ZG)
BEBAL 15
15 x 20W MAX G4 230/12V



CE IP20   

Base: Rame
Finitura: Cromo (CR)
Opzioni: Rame (RA), Zincatura Bianca (ZB), Gialla (ZG)
Particolarità: Steli modellabili
Trasformatore: Toroidale inserito nella base
Lampadina: Alogena bispina
Peso e misure con imballo: 15 kg - 800 x 800 x 930 mm

Base: Copper
Finish: Chrome (CR)
Options: Copper (RA), White (ZB), Yellow (ZG) Galvanized
Detail: Mouldable stems
Transformer: Toroidal within the base
Lamp: Double plug-in halogen
Weight and Measurements including Packaging: 15 kg - 800 x 800 x 930 mm

Base: Cuivre
Finition: Chrome (CR)
Options: Cuivre (RA), Zingage Blanc (ZB), Jaune (ZG)
Particolarité: Tiges modelables
Transformateur: Toroidal inséré dans le socle
Ampoule: Halogène bi-pin
Poids et mesures avec emballage: 15 kg - 800 x 800 x 930 mm

Base: Cobre
Acabado: Cromo (CR)
Opciones: Cobre (RA), Galvanizado con zinc en Blanco (ZB), Amarillo (ZG)
Particularidades: Tubos moldeables
Transformador: Toroidal introducido en la base
Bombilla: Halógena doble enchufe
Peso y medidas con embalaje: 15 kg - 800 x 800 x 930 mm



Cod. 7504



NEKIR
3 x 50W MAX Ø5 I
GU5,3 230/12V



CE IP20   

Cod. 7504 BIS

NEKIR
4 x 50W MAX Ø5 I
GU5,3 230/12V

CE IP20   

Base: Metallo
Steli: Cromati
Finitura: Base verniciata grigia, stelo cromato
Particolarità: Coprilampada in vetro silconico
Trasformatore: Toroidale inserito nella base
Lampadina: Dichroica
Peso e misure con imballo: 8 kg - 360 x 2.150 x 300 mm

Base: Metal
Stems: Chrome
Finish: Gray painted (base), chrome stem
Detail: Silicone-glass lampshade
Transformer: Toroidal within the base
Lamp: Dichroic
Weight and Measurements including Packaging: 8 kg - 360 x 2.150 x 300 mm

Base: Métal
Tiges: Cromées
Finition: Base peinte gris, tiges chromée
Particolarité: Abat-jour en verre silicóné
Transformateur: Toroidal inséré dans la base
Ampoule: Dichroïque
Poids et mesures avec emballage: 8 kg - 360 x 2.150 x 300 mm

Base: Metal
Tubo: Cromo
Acabado: Base barnizada gris, tubo cromado
Particularidades: Cubrelámpara de cristal silicona
Transformador: Toroidal introducido en la base
Bombilla: Dichroica
Peso y medidas con embalaje: 8 kg - 360 x 2.150 x 300 mm

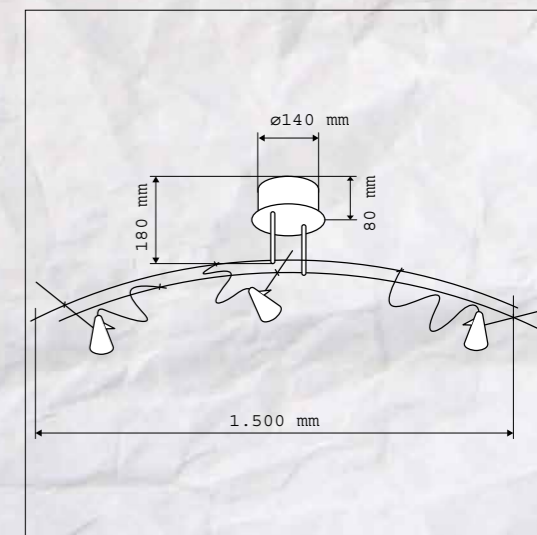
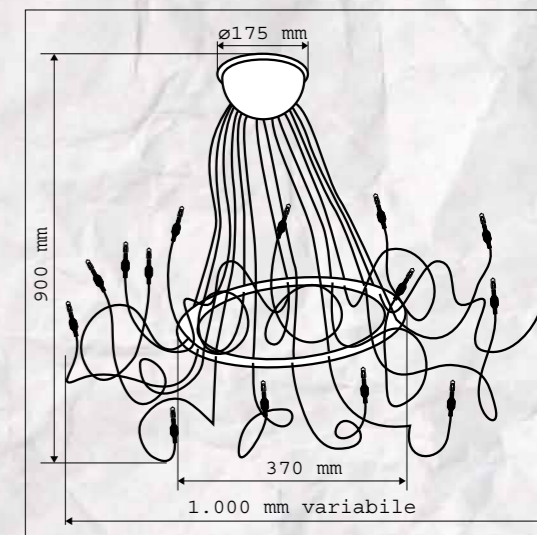
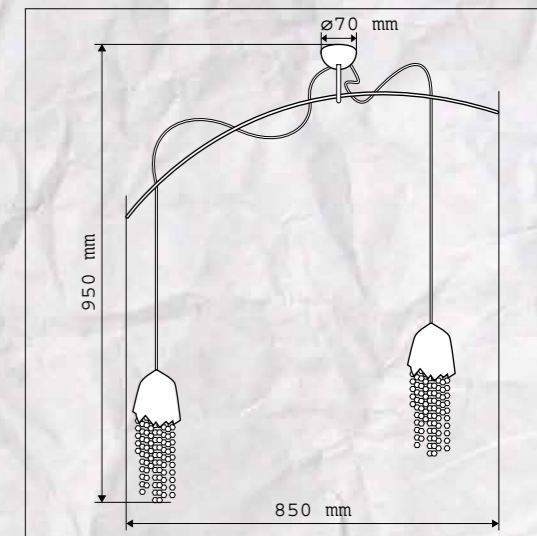



Cod. 7507 CR



OPZIONI: (RA) (VB) (VNM) (ZB) (ZG)

CINCIALLEGRE

9 x 40W (60W MAX)

E 14 230V



CE IP20  

Base: Metallo
Stelo: Rame
Finitura: Base verniciata grigia e steli cromati
Opzioni: Rame (RA), Verniciatura Bianca (VB), Nera Micacea (VNM)
Zincatura Bianca (ZB) Gialla (ZG)
Particolarità: Steli modellabili
Lampadina: Colpo di vento
Peso e misure con imballo: 7,5 kg - 560 x 460 x 750 mm
Opzioni: Con più steli

Base: Metal
Stem: Copper
Finish: Gray painted base and chrome stems
Options: Copper (RA), White Paint (VB), Black Micaceous (VNM), Galvanized White (ZB), Yellow (ZG)
Detail: Mouldable stems
Lamp: Gust of wind
Weight and Measurements including Packaging: 7.5 kg - 560 x 460 x 750 mm
Options: More stems

Base: Métal
Tiges: Cuivre
Finition: Base peint gris et tiges chromé
Options: Cuivre (RA), Peinture Blanc (VB), Noire Micacé (VNM), Zingage Blanc (ZB), Jaune (ZG)
Particularité: Tiges modelables
Ampoule: Coup de vent
Poids et mesures avec emballage: 7,5 kg - 560 x 460 x 750 mm
Options: Avec plusieurs tiges

Base: Metal
Tubo: Cobre
Acabado: Base barnizado gris y tubos cromado
Opciones: Cobre (RA), Barnizado Blanco (VB), Negro Micáceo (VNM), Galvanizado con Zinc en Blanco (ZB) Amarillo (ZG)
Particularidades: Tubos moldeables
Bombilla: Golpe de viento
Peso y medidas con embalaje: 7.5 kg - 560 x 460 x 750 mm
Opciones: Con más tubos

Cod. 7507 VB



OPZIONI: (CR) (RA) (VNM) (ZB) (ZG)

CINCIALLEGRE

9 x 40W (60W MAX)

E 14 230V



CE IP20  

Base: Metallo
Stelo: Rame
Finitura: Base e steli verniciati bianchi (VB)
Opzioni: Cromo (CR), Rame (RA), Verniciatura Nera Micacea (VNM), Zincatura Bianca (ZB) Gialla (ZG)
Particolarità: Steli modellabili
Lampadina: Colpo di vento
Peso e misure con imballo: 7,5 kg - 560 x 460 x 750 mm
Opzioni: Con più steli

Base: Metal
Stem: Copper
Finish: White painted base and stems
Options: Chrome (CR), Copper (RA), Black Paint Micaceous (VNM), Galvanized White (ZB), Yellow (ZG)
Detail: Mouldable stems
Lamp: Gust of wind
Weight and Measurements including Packaging: 7.5 kg - 560 x 460 x 750 mm
Options: More stems

Base: Métal
Tiges: Cuivre
Finition: Base et tiges Peintes Blanc (VB)
Options: Chrome (CR), Cuivre (RA), Peinture Noire Micacé (VNM), Zingage Blanc (ZB), Jaune (ZG)
Particularité: Tiges modelables
Ampoule: Coup de vent
Poids et mesures avec emballage: 7,5 kg - 560 x 460 x 750 mm
Options: Avec plusieurs tiges

Base: Metal
Tubo: Cobre
Acabado: Base y tubos Barnizados Blancos (VB)
Opciones: Cromo (CR), Cobre (RA), Barnizado Negro Micáceo (VNM), Galvanizado con Zinc en Blanco (ZB) Amarillo (ZG)
Particularidades: Tubos moldeables
Bombilla: Golpe de viento
Peso y medidas con embalaje: 7.5 kg - 560 x 460 x 750 mm
Opciones: Con más tubos



Cod. 7517

FLOWERS

5 x 20W MAX G4 230/12V

1 x 23W MAX E27 230V FBT



CE IP20   

Base: Metallo
Stelo: Plexiglass sabbiato
Finitura: Cromo
Particolarità: Veri fiori finti
Trasformatore: Toroidale inserito nella struttura
Lampadina: Alogena bispina + risparmio energetico
Peso e misure con imballo: 5,6 kg - 750 x 450 x 300 mm

Base: Metal
Stem: Sandblasted plexiglas
Finish: Chrome
Detail: Genuine artificial flowers
Transformer: Toroidal within the structure
Lamp: Double plug-in halogen + energy-saving
Weight and Measurements including Packaging: 5,6 kg - 750 x 450 x 300 mm

Base: Métal
Tiges: Plexiglas sablé
Finition: Chrome
Particularité: Vraies fausses fleurs
Transformateur: Toroidal inséré dans la structure
Ampoule: Halogène bi-pin + économie d'énergie
Poids et mesures avec emballage: 5,6 kg - 750 x 450 x 300 mm

Base: Metal
Tubo: Plexiglas arenado
Acabado: Cromo
Particularidades: Verdaderas flores falsas
Transformador: Toroidal introducido en la estructura
Bombilla: Halógena doble enchufe + bajo consumo energético
Peso y medidas con embalaje: 5,6 kg - 750 x 450 x 300 mm

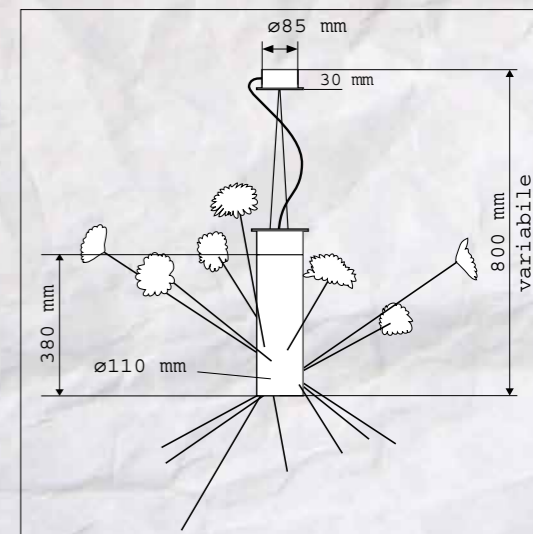
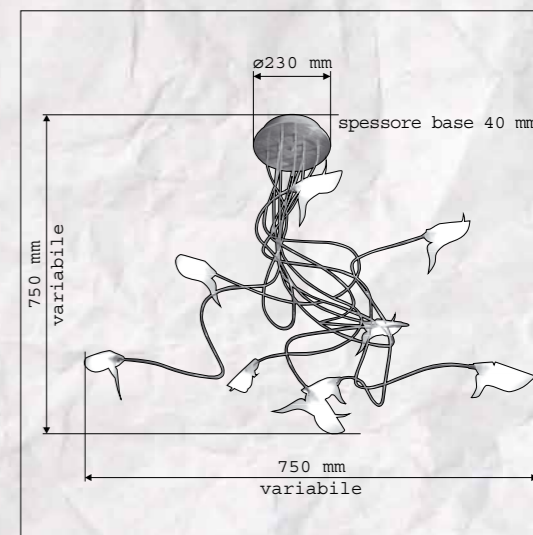



Cod. 7510

Z O T
1 50W MAX
R7s 230V

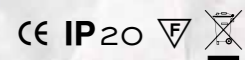

Base: Alluminio verniciato grigio
Stelo: Cromato
Particolarità: Cavi trasparenti e collare cromato, gira su se stessa
Lampadina: Alogena lineare corta
Peso e misure con imballo: 1,7 kg - ø155 x 1.110 mm

Base: Grey paint aluminium
Stem: Chrome
Detail: Transparent cables and chromium plated collar, it turns on itself
Lamp: Linear short halogen
Weight and Measurements including Packaging: 1.7 kg - ø155 x 1.110 mm

Base: Aluminium peint gris
Tige: Chrome
Particularité: Câbles transparents et collier chromé, tourne sur elle-même
Ampoule: Halogène linéaire courte
Poids et mesures avec emballage: 1,7 kg - ø 155 x 1.110 mm

Base: Aluminio barnizado gris
Tubo: Cromo
Particularidades: Cables transparentes y corona cromada, gira sobre sí misma
Bombilla: Halógena lineal corta
Peso y medidas con embalaje: 1,7 kg - ø155 x 1.110 mm



Cod. 7511

Z O T 2
2 x 1 50W MAX
R7s 230V

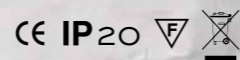

Base: Alluminio verniciato grigio
Stelo: Cromato
Particolarità: Cavi trasparenti e collare cromato, girano su se stessi
Lampadina: Alogena lineare corta
Peso e misure con imballo: 2,7 kg - 1.130 x 460 x 120 mm

Base: Grey paint aluminium
Stems: Chrome
Detail: Transparent cables and chromium plated collar, they each spin independently
Lamp: Linear short halogen
Weight and Measurements including Packaging: 2.7 kg - 1.130 x 460 x 120 mm

Base: Aluminium peint gris
Tiges: Chrome
Particularité: Câbles transparents et collier chromé, tournent sur elles-mêmes
Ampoule: Halogène linéaire courte
Poids et mesures avec emballage: 2,7 kg - 1.130 x 460 x 120 mm

Base: Aluminio barnizado gris
Tubo: Cromo
Particularidades: Cables transparentes y corona cromada, giran sobre sí mismas
Bombilla: Halógena lineal corta
Peso y medidas con embalaje: 2,7 kg - 1.130 x 460 x 120 mm



Cod. 7515 ZG

OPZIONI: (CR) (RA) (ZB)
O R I A S
5 x 20W MAX
G4 230/1 2V

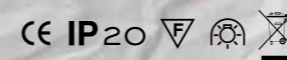

Base: Rame
Stelo: Rame
Finitura: Zincatura gialla (ZG)
Opzioni: Cromo (CR), Rame (RA), Zincatura Bianca (ZB)
Particolarità: Steli modellabili
Trasformatore: Toroidale inserito nella base
Lampadina: Alogena bispina
Peso e misure con imballo: 3,9 kg - 250 x 400 x 500 mm

Base: Copper
Stem: Copper
Finish: Yellow galvanized
Options: Chrome (CR), Copper (RA), Galvanized White (ZB)
Detail: Mouldable stems
Transformer: Toroidal within the base
Lamp: Double plug-in halogen
Weight and Measurements including Packaging: 3.9 kg - 250 x 400 x 500 mm

Base: Cuivre
Tige: Cuivre
Finition: Zingage Jaune (ZG)
Options: Chrome (CR), Cuivre (RA), Zingage Blanc (ZB)
Particularité: Tiges modelables
Transformateur: Toroidal inséré dans la base
Ampoule: Halogène bi-pin
Poids et mesures avec emballage: 3,9 kg - 250 x 400 x 500 mm

Base: Cobre
Tubo: Cobre
Acabado: Galvanizado con Zinc en Amarillo (ZG)
Opciones: Cromo (CR) Cobre (RA) Galvanizado con Zinc en Blanco (ZB)
Particularidades: Tubos moldeables
Transformador: Toroidal introducido en la base
Bombilla: Halógena doble enchufe
Peso y medidas con embalaje: 3,9 kg - 250 x 400 x 500 mm

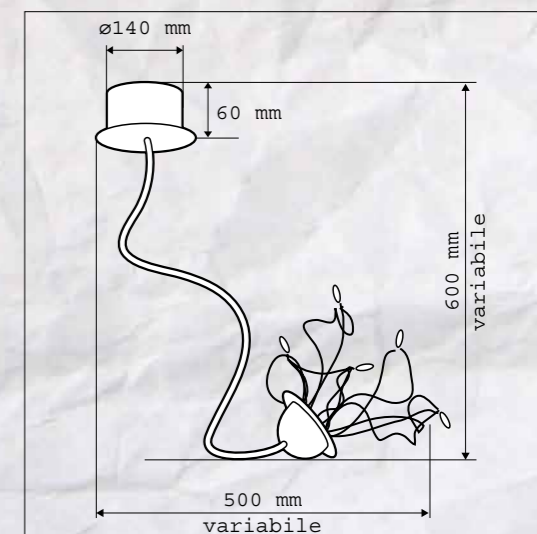
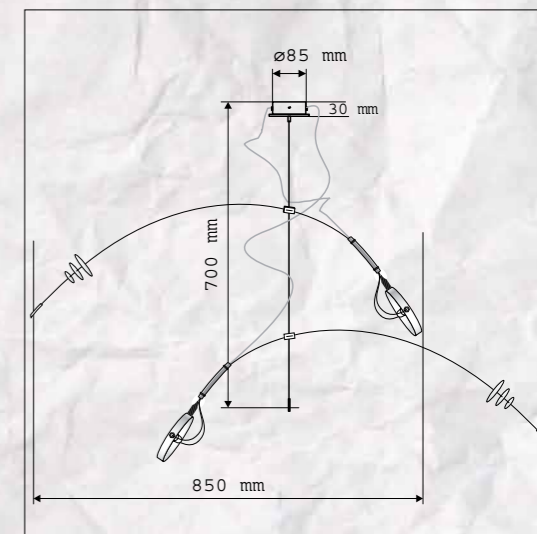
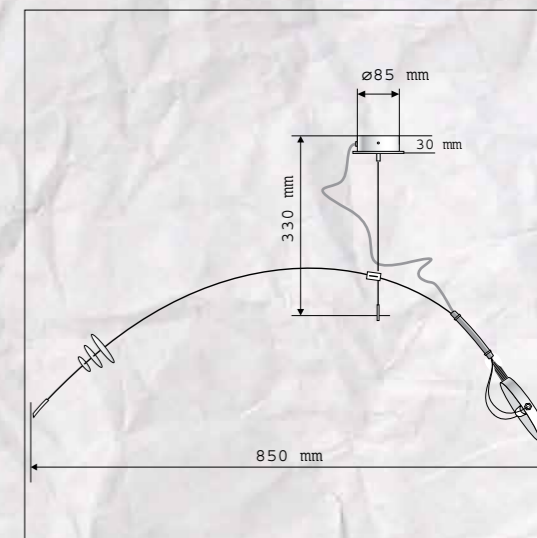



Cod. 7532 (ZG) (VB) Disco Centrale Foglia Rame - Copper Foil Central Disk
Cod. 7518/12 (ZG) (VB) Feuille de Cuivre Disque Central - Hoja de Cobre Disco Central

Cod. 7532 (VNM) (ZB) Disco Centrale Foglia Argento - Silver Foil Central Disk
Cod. 7518/12 (VNM) (ZB) Feuille de Argent Disque Central - Hoja de Plata Disco Central

Cod. 7516 (ZB) Disco Centrale Foglia Argento - Silver Foil Central Disk
 Feuille de Argent Disque Central - Hoja de Plata Disco Central

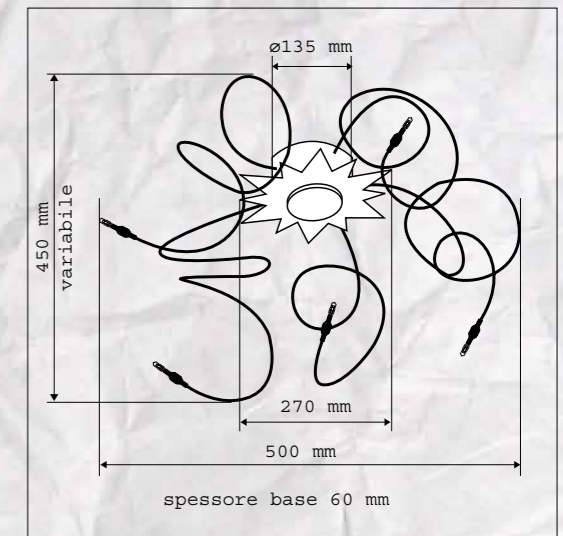

Cod. 7532 ZG

OPZIONI: (CR) (VB) (VNM) (ZB)

MINI FAAL

5 x 20W MAX

G4 230/12V

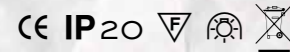

Base: Metallo spazzolato
 Stelo: Rame
 Finitura: Zincatura gialla e disco centrale foglia rame
 Opzioni: Cromo (CR), Verniciatura Bianca (VB), Nera Micacea (VNM), Zincatura Bianca (ZB)
 Particolarità: Disco centrale in foglia rame e steli modellabili
 Trasformatore: Toroidale inserito nella base
 Lampadina: Alogena bispina
 Peso e misure con imballo: 5,5 kg - 750 x 450 x 300 mm

Base: Brushed metal
 Stem: Copper
 Finish: Galvanized Yellow and copper leaves
 Options: Chrome (CR), White Paint (VB), Black Micaceous (VNM), Galvanized White (ZB)
 Detail: Copper-foil central disk and mouldable stems
 Transformer: Toroidal within the base
 Lamp: Double plug-in halogen
 Weight and Measurements including Packaging: 5,5 kg - 750 x 450 x 300 mm

Base: Métal brossé
 Tiges: Cuivre
 Finition: Zingage Jaune et feuille cuivre
 Options: Chrome (CR), Peinture Blanche (VB), Noire Micacé (VNM), Zingage Blanc (ZB)
 Particularité: Disque central en Feuille de cuivre et tiges modelables
 Transformateur: Toroidal inséré dans la base
 Ampoule: Halogène bi-pin
 Poids et mesures avec emballage: 5,5 kg - 750 x 450 x 300 mm

Base: Metal cepillado
 Tubo: Cobre
 Acabado: Galvanizado con Zinc en Amarillo y hoja de cobre
 Opciones: Cromo (CR), Barnizado Blanco (VB), Negro Micáceo (VNM), Galvanizado con Zinc en Blanco (ZB)
 Particularidades: Hoja de cobre disco central y tubos moldeables
 Transformador: Toroidal introducido en la base
 Bombilla: Halógena doble enchufe
 Peso y medidas con embalaje: 5,5 kg - 750 x 450 x 300 mm

Cod. 7518/12 CR

OPZIONI: (VB) (VNM) (ZB) (ZG)

FAAL SMALL

12 x 20W MAX

G4 230/12V

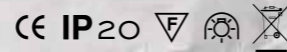

Base: Metallo
 Stelo: Rame
 Finitura: Cromo (CR)
 Opzioni: Verniciatura Bianca (VB) Nera Micacea (VNM), Zincatura Bianca (ZB), Gialla (ZG)
 Particolarità: Disco centrale cromato e steli modellabili
 Trasformatore: Toroidale inserito nella base
 Lampadina: Alogena bispina
 Peso e misure con imballo: 11 kg - 750 x 560 x 460 mm
 Opzioni: Con meno steli

Base: Metal
 Stem: Copper
 Finish: Chrome
 Options: White Paint (VB), Black Micaceous (VNM), Galvanized White (ZB) Yellow (ZG)
 Detail: Chrome central disk and mouldable stems
 Transformer: Toroidal within the base
 Lamp: Double plug-in halogen
 Weight and Measurements including Packaging: 11 kg - 750 x 560 x 460 mm
 Options: With fewer stems

Base: Métal
 Tiges: Cuivre
 Finition: Chrome
 Options: Peinture Blanche (VB), Noire Micacé (VNM), Zingage Blanc (ZB), Jaune (ZG)
 Particularité: Feuille de cuivre disque central et tiges modelables
 Transformateur: Toroidal inséré dans la base
 Ampoule: Halogène bi-pin
 Poids et mesures avec emballage: 11 kg - 750 x 560 x 460 mm
 Options: Avec moins de tiges

Base: Metal
 Tubo: Cobre
 Acabado: Cromo (CR)
 Opciones: Barnizado Blanco (VB) Negro Micáceo (VNM), Galvanizado con zinc en Blanco (ZB), Amarillo (ZG)
 Particularidades: Hoja de cobre disco central y tubos moldeables
 Transformador: Toroidal introducido en la base
 Bombilla: Halógena doble enchufe
 Peso y medidas con embalaje: 11 kg - 750 x 560 x 460 mm
 Opciones: Con menos tubos

Cod. 7516 ZG

OPZIONE: (ZB)

FAAL

12 x 20W MAX

G4 230/12V

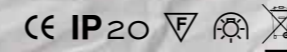

Base: Metallo spazzolato
 Stelo: Rame
 Finitura: Zincatura gialla e foglia rame
 Opzione: Zincatura Bianca (ZB)
 Particolarità: Disco centrale in foglia rame e steli modellabili
 Trasformatore: Toroidale inserito nella base
 Lampadina: Alogena bispina
 Peso e misure con imballo: 15 kg - 800 x 800 x 520 mm
 Opzione: Con più steli

Base: Brushed metal
 Stem: Copper
 Finish: Yellow galvanized and copper-foil
 Option: White galvanized (ZB)
 Detail: Copper-foil central disk and mouldable stems
 Transformer: Toroidal within the base
 Lamp: Double plug-in halogen
 Weight and Measurements including Packaging: 15 kg - 800 x 800 x 520 mm
 Option: More stems

Base: Métal brossé
 Tiges: Cuivre
 Finition: Zingage Jaune et feuille cuivre
 Options: Zingage Blanc (ZB)
 Particularité: Disque central en Feuille de cuivre et tiges modelables
 Transformateur: Toroidal inséré dans la base
 Ampoule: Halogène bi-pin
 Poids et mesures avec emballage: 15 kg - 800 x 800 x 520 mm
 Option: Avec plusieurs tiges

Base: Metal cepillado
 Tubo: Cobre
 Acabado: Galvanizado con zinc en Amarillo y hoja de cobre
 Opciones: Galvanizado con zinc en Blanco (ZB)
 Particularidades: Hoja de cobre disco central y tubos moldeables
 Transformador: Toroidal introducido en la base
 Bombilla: Halógena doble enchufe
 Peso y medidas con embalaje: 15 kg - 800 x 800 x 520 mm
 Opciones: Con más tubos

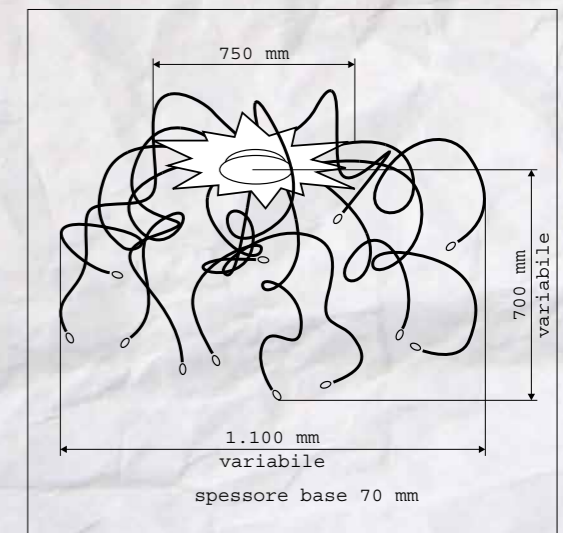
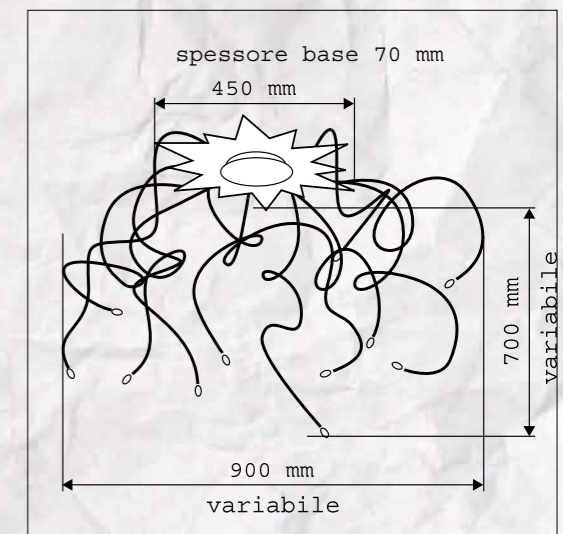



Cod. 7519 ZB

OPZIONI: (CR) (VB) (VNM) (ZG)

TOQUÌ

12 x 40W MAX

E14 230V

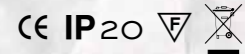

Base: Metallo
Stelo: Rame
Finitura: Zincatura Bianca (ZB)
Opzioni: Cromo (CR), Verniciatura Bianca (VB), Nera Micacea (VNM), Zincatura Gialla (ZG)
Particolarità: Steli modellabili e pendenti in cristallo
Lampadina: Colpo di vento
Peso e misure con imballo: 10 kg - 480 x 490 x 1.150 mm

Base: Metal
Stem: Copper
Finish: Galvanized White (ZB)
Options: Chrome (CR), White Paint (VB) Black Micaceous (VNM), Galvanized Yellow (ZG)
Detail: Mouldable stems and crystal pendants
Lamp: Gust of wind
Weight and Measurements including Packaging: 10 kg - 480 x 490 x 1.150 mm

Base: Métal
Tiges: Cuivre
Finition: Zingage Blanc (ZB)
Options: Chrome (CR), Peinture Blanche (VB), Noire Micacé (VNM), Zingage Jaune (ZG)
Particularité: Tiges modelables, pendants en cristal
Ampoule: Coup de vente
Poids et mesures avec emballage: 10 kg - 480 x 490 x 1.150 mm

Base: Metal
Tubo: Cobre
Acabado: Galvanizado con Zinc en Blanco (ZB)
Opciones: Cromo (CR), Barnizado Blanco (VB), Negro Micáceo (VNM), Galvanizado en Amarillo (ZG)
Particularidades: Tubos moldeables y colgantes de cristal
Bombilla: Golpe de viento
Peso y medidas con embalaje: 10 kg - 480 x 490 x 1.150 mm



Cod. 7519 VNM

OPZIONI: (CR) (VB) (ZB) (ZG)

TOQUÌ

12 x 40W MAX

E14 230V

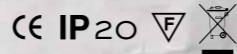

Base: Metallo
Stelo: Rame
Finitura: Verniciatura Nera Micacea (VNM)
Opzioni: Cromo (CR), Verniciatura Bianca (VB), Zincatura Bianca (ZB), Gialla (ZG)
Particolarità: Steli modellabili e pendenti in cristallo
Lampadina: Colpo di vento
Peso e misure con imballo: 10 kg - 480 x 490 x 1.150 mm

Base: Metal
Stem: Copper
Finish: Painted Black Micaceous (VNM)
Options: Chrome (CR), White Paint (VB), Galvanized White (ZB), Yellow (ZG)
Detail: Mouldable stems and crystal pendants
Lamp: Gust of wind
Weight and Measurements including Packaging: 10 kg - 480 x 490 x 1.150 mm

Base: Métal
Tiges: Cuivre
Finition: Peinture Noire Micacé (VNM)
Options: Chrome (CR), Peinture Blanche (VB), Zingage Blanc (ZB), Jaune (ZG)
Particularité: Tiges modelables, pendants en cristal
Ampoule: Coup de vente
Poids et mesures avec emballage: 10 kg - 480 x 490 x 1.150 mm

Base: Metal
Tubo: Cobre
Acabado: Barnizado Negro Micáceo (VNM)
Opciones: Cromo (CR), Barnizado Blanco (VB), Galvanizado con Zinc en Blanco (ZB), Amarillo (ZG)
Particularidades: Tubos moldeables y colgantes de cristal
Bombilla: Golpe de viento
Peso y medidas con embalaje: 10 kg - 480 x 490 x 1.150 mm

LUCIFERO

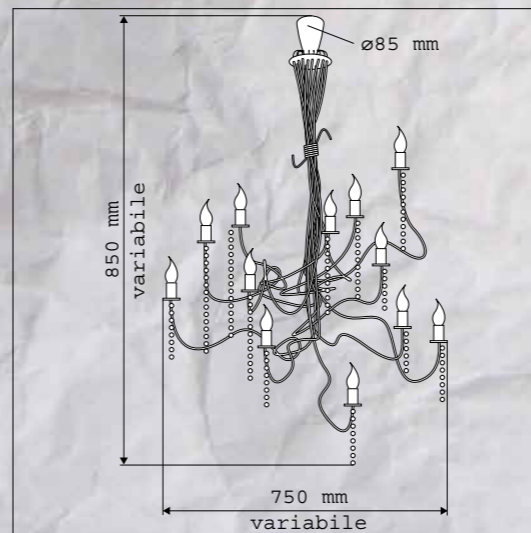



Ristorante Lago dei Salici - (CN)
Restaurant - Lago dei Salici - (CN) - ITALY



DOHA - QATAR
ESECUZIONE SPECIALE - LAMPADA SOSPENSIONE 36 mt.
SPECIAL WORKS - SUSPENSION LAMP 100 ft.

Video Doha





Agriturismo Casa Oberth

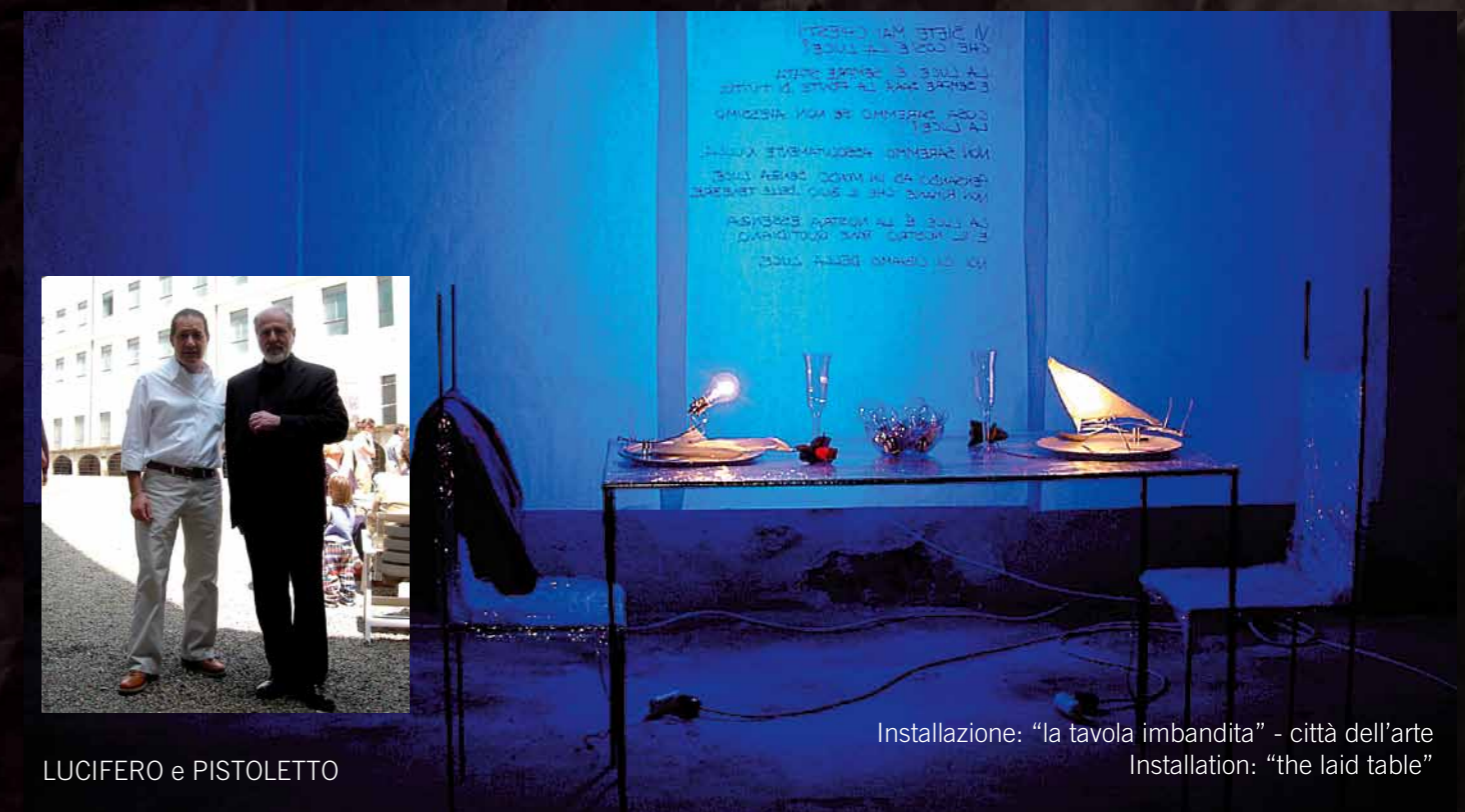

LUCIFERO e PISTOLETTO

Installazione: "la tavola imbandita" - città dell'arte
Installation: "the laid table"

PECCATI DI LUCE

Adamo ed Eva. Il frutto proibito. Il peccato originale. Dal paradiso terrestre, due nuove creazioni dedicate al giardino per un viaggio tra tentazioni, design, creatività. Luce/ombra, angeli/demoni, dualità in armonia: da sempre il regno di Lucifero.

STRUTTURA: ACCIAIO CORTEN
FIGURA: DOPPIA COMPONENTE SU TELAIO IN METALLO SCATOLATO
BASE: TUBO ALTEZZA 1.200 MM (DI CUI 800 MM INTERRATO)
PARTICOLARITÀ: ARRUGGINIMENTO NATURALE ALLE INTEMPERIE

Cod. 9702

A D A M O

Cod. 9703

E V A

FARETTI C/LAMPADA
IODURI METALLICI
3x35W
GX 10 230V 

CE IP65  

ALIMENTATORI INSERITI
NEL CILINDRO FARETTI

PESO E MISURE CON IMBALLO ADAMO:
146 KG - 2.270 x 400 x 1100 MM
540 x 540 x 620 MM

PESO E MISURE CON IMBALLO EVA:
101 KG - 2.270 x 400 x 750 MM
540 x 540 x 620 MM

ADAMO



EVA

SINS OF LIGHT

Adam and Eve. The forbidden fruit. The original sin. From an earthly paradise, two new creations dedicated to the garden for a journey between temptations, design and creativity. Light/Shadow, Angels/Demons, a dual of harmony: forever the realm of Lucifer.

STRUCTURE: CORTEN STEEL
FORM: NO 2 SECTIONAL BODIES ON BOX TYPE METAL FRAME
BASE: PIPE, TOTAL HEIGHT 1.200 MM (OF WHICH 800 MM UNDERGROUND)
DETAIL: NATURAL RUSTING THROUGH WEATHERING



Cod. 9702

A D A M O

Cod. 9703

E V A

SPOT LIGHTS WITH
METALLIC IODIDE BULB
3x35W
GX 10 230V 

CE IP65  

POWER SUPPLY WITHIN
THE SPOTLIGHT CYLINDER

WEIGHT AND MEASUREMENTS INCLUDING
PACKAGING FOR ADAMO:
146 KG - 2.270 x 400 x 1100 MM
540 x 540 x 620 MM

WEIGHT AND MEASUREMENTS INCLUDING
PACKAGING FOR EVA:
101 KG - 2.270 x 400 x 750 MM
540 x 540 x 620 MM



Casa Privata
Private House



Casa Privata
Private House



Casa Privata
Private House



Villa Maggiorana



Villa Gualino

EROTH
EROTH
EROTH

Cod. 9700 (TERRA)

1 x 23W E27 FBT 230V
C/LAMPADA A RISPARMIO ENERGETICO

CE IP55 

MATERIALE: POLIPROPILENE
ADATTATORE PER PALO Ø 60MM
FORNITO SENZA PALO

PESO E MISURE CON IMBALLO:
6 KG - 1.150 X 300 X 490 MM
WEIGHT AND MEASUREMENTS INCLUDING PACKAGING:
6 KG - 1.150 X 300 X 490 MM



Cod. 9701 (PARETE)

1 x 23W E27 FBT 230V
C/LAMPADA A RISPARMIO ENERGETICO

CE IP55 

MATERIALE: POLIPROPILENE
STAFFA: INGOMBRO 30 CM
PESO E MISURE CON IMBALLO:
7,5 KG - 1.150 X 300 X 490 MM
WEIGHT AND MEASUREMENTS INCLUDING PACKAGING:
7,5 KG - 1.150 X 300 X 490 MM

LUCIFERO ILLUMINA I VOSTRI GIARDINI



Casa Obert (Bed & Breakfast)



AX 001

AX 002

AX 003

AX 004

AX 005

AX 006

AX 007

ANDROID Y2K11

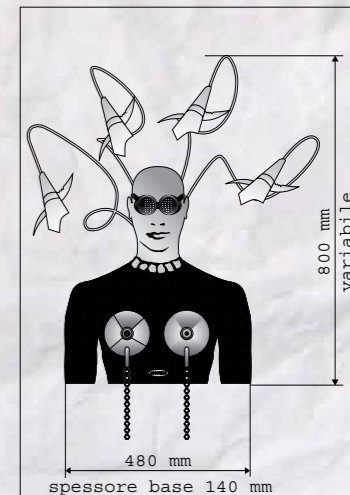
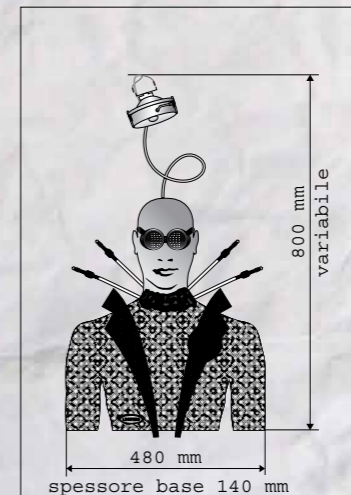
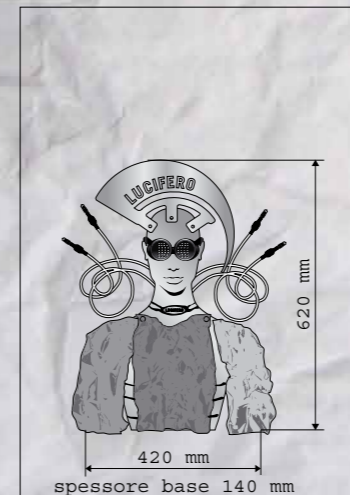
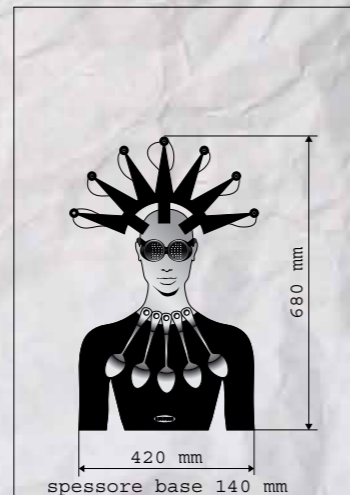
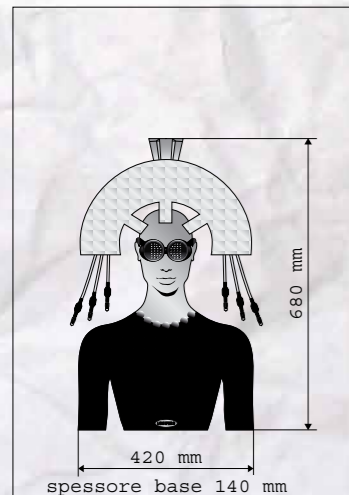

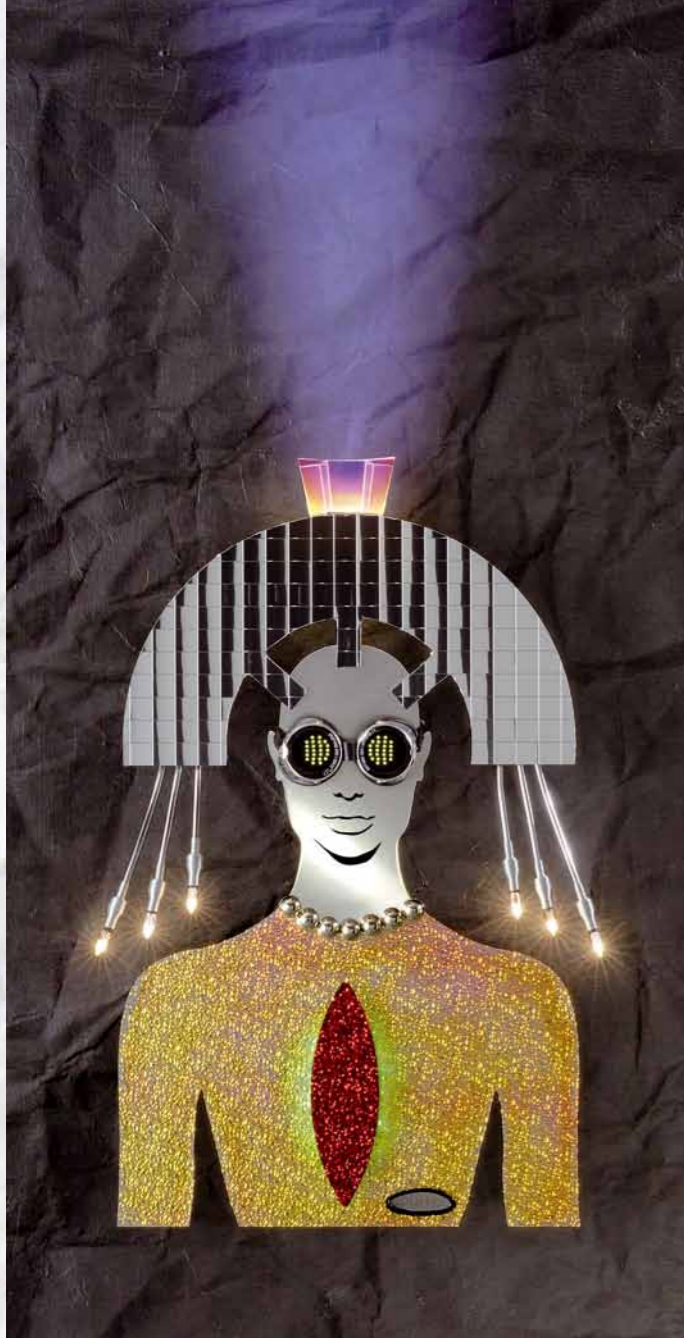

CODICE: AX 001



Figura: Alluminio
 Finitura: Pellicola Iridescente + Mosaico Sintetico Cromato
 Steli: Rame Cromato
 Lampadine: nr. 1 Dichroica Blu 50W 12V + 6 Bispina 10W G4 12V
 LED SMD: Verdi + 2 LED G4 per gli occhi
 Trasformatore e alimentatore elettronico: 230V 12V inseriti nella base
 Peso e misure con imballo: 4 Kg - 350 x 260 x 1.130 mm

Figure: Aluminium
 Finish: Iridescent Film + Chrome Synthetic Mosaic
 Stem: Chrome Copper
 Bulb: no.1 Blue Dichroic 50W 12V + 6 Two-pin 10W G4 12V
 LED SMD: Green + 2 G4 LED for the eyes
 Electronic transformer and feed supply: 230V 12V in base
 Weight and measurements including packaging: 4 Kg - 350 x 260 x 1.130 mm

Figure: Aluminium
 Finition: Pellicule Iridescente + Mosaïque Synthétique Chromée
 Tiges: Cuivre Chromé
 Ampoules: n° 1 Dichroïque Bleu 50W 12V + 6 Bispina 10W G4 12V
 LED SMD: Verts + 2 LED G4 pour les yeux
 Transformateur et alimentation: électronique 230V 12V insérés dans la base
 Poids et mesure avec emballage: 4 Kg - 350 x 260 x 1.130 mm

Figura: Aluminio
 Acabado: Película Iridescente + Mosaico Sintético Cromado
 Tubos: Cobre Cromado
 Bombillas: n° 1 Dichroica Azul 50W 12V + 6 con doble enchufe 10W G4 12V
 LED SMD: Verdes + 2 LED G4 para los ojos
 Transformador y alimentador electrónico: 230V 12V introducidos en la base
 Peso y medidas con embalaje: 4 Kg - 350 x 260 x 1.130 mm

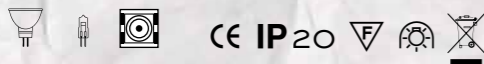

CODICE: AX 002



Figura: Alluminio
 Finitura: Quash Nero + Mosaico Sintetico Dorato
 Steli: Flessibili in ottone cromati
 Lampadine: nr. 2 Halospot 50W 12V
 LED SMD: Blu + 2 LED G4 per gli occhi
 Trasformatore e alimentatore elettronico: 230V 12V inseriti nella base
 Peso e misure con imballo: 4 Kg - 350 x 260 x 1.130 mm

Figure: Aluminium
 Finish: Black Quash + Gold Synthetic Mosaic
 Stem: Flexible Chrome
 Bulb: no. 2 Halospot 50W 12V
 LED SMD: Blue + 2 G4 LED for the eyes
 Electronic transformer and feed supply: 230V 12V in base
 Weight and measurements including packaging: 4 Kg - 350 x 260 x 1.130 mm

Figure: Aluminium
 Finition: Quash Noir + Mosaïque Synthétique Dorée
 Tiges: Flexibles Chromées
 Ampoules: n° 2 Halospot 50W 12V
 LED SMD: Bleu + 2 LED G4 pour les yeux
 Transformateur et alimentation: électronique 230V 12V insérés dans la base
 Poids et mesure avec emballage: 4 Kg - 350 x 260 x 1.130 mm

Figura: Aluminio
 Acabado: Quash Negro + Mosaico Sintético Dorado
 Tubos: Flexibles Cromados
 Bombillas: n° 2 Halospot 50W 12V
 LED SMD: Azul + 2 LED G4 para los ojos
 Transformador y alimentador electrónico: 230V 12V introducidos en la base
 Peso y medidas con embalaje: 4 Kg - 350 x 260 x 1.130 mm

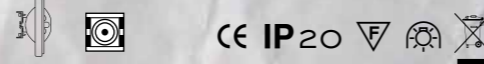

CODICE: AX 003



Figura: Alluminio
 Finitura: Tessuto Decorato e Cucchiaini Inox
 Corona: Alluminio e tessuto dorato
 Lampadine: nr. 7 Bispina 20W G4 12V
 LED SMD: 2 LED G4 per gli occhi
 Trasformatore e alimentatore elettronico: 230V 12V inseriti nella base
 Peso e misure con imballo: 4 Kg - 350 x 260 x 1.130 mm

Figure: Aluminium
 Finish: Decorated Fabric and Stainless Steel Spoons
 Crown: Aluminium and gold fabric
 Bulb: no. 7 Two-pin 20W G4 12V
 LED SMD: 2 G4 LED for the eyes
 Electronic transformer and feed supply: 230V 12V in base
 Weight and measurements including packaging: 4 Kg - 350 x 260 x 1.130 mm

Figure: Aluminium
 Finition: Tissu Décoré et Cuillères Inox
 Couronne: aluminium et de tissu d'or
 Ampoules: n° 7 Bispina 20W G4 12V
 LED SMD: 2 LED G4 pour les yeux
 Transformateur et alimentation: électronique 230V 12V insérés dans la base
 Poids et mesure avec emballage: 4 Kg - 350 x 260 x 1.130 mm

Figura: Aluminio
 Acabado: Tejido Decorado y Cucharas Inox
 Corona: de aluminio y tela de oro
 Bombillas: n° 7 con doble enchufe 20W G4 12V
 LED SMD: 2 LED G4 para los ojos
 Transformador y alimentador electrónico: 230V 12V introducidos en la base
 Peso y medidas con embalaje: 4 Kg - 350 x 260 x 1.130 mm

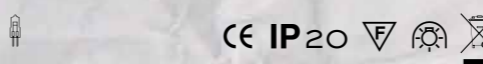

CODICE: AX 004



Figura: Alluminio
 Finitura: Tessuto Decorato e Applicazioni Varie
 Steli: Flessibili in ottone
 Lampadine: nr. 6 Bispina 20W G4 12V
 LED SMD: Rossi + 2 LED G4 per gli occhi
 Trasformatore e alimentatore elettronico: 230V 12V inseriti nella base
 Peso e misure con imballo: 4 Kg - 350 x 260 x 1.130 mm

Figure: Aluminium
 Finish: Decorated Fabric and Various Applications
 Stems: Flexible Brass
 Bulb: no. 6 Two-pin 20W G4 12V
 LED SMD: Red + 2 G4 LED for the eyes
 Electronic transformer and feed supply: 230V 12V in base
 Weight and measurements including packaging: 4 Kg - 350 x 260 x 1.130 mm

Figure: Aluminium
 Finition: Tissu Décoré et Applications Variées
 Tiges: Flexibles Laitonnées
 Ampoules: n° 6 Bispina 20W G4 12V
 LED SMD: Rouges + 2 LED G4 pour les yeux
 Transformateur et alimentation: électronique 230V 12V insérés dans la base
 Poids et mesure avec emballage: 4 Kg - 350 x 260 x 1.130 mm

Figura: Aluminio
 Acabado: Tejido Decorado y Varias Aplicaciones
 Tubos: Flexibles latonados
 Bombillas: n° 6 con doble enchufe 20W G4 12V
 LED SMD: Rojos + 2 LED G4 para los ojos
 Transformador y alimentador electrónico: 230V 12V introducidos en la base
 Peso y medidas con embalaje: 4 Kg - 350 x 260 x 1.130 mm

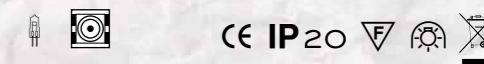

CODICE: AX 005



Figura: Alluminio
 Finitura: Alluminio Colorato e Foglia Rame
 Steli: Rame
 Lampadine: nr. 4 Bispina 20W G4 12V
 LED SMD: Bianchi + 2 LED G4 per gli occhi
 Trasformatore e alimentatore elettronico: 230V 12V inseriti nella base
 Peso e misure con imballo: 4 Kg - 350 x 260 x 1.130 mm

Figure: Aluminium
 Finish: Coloured Aluminium and Copper Leaves
 Stems: Copper
 Bulb: no. 4 Two-pin 20W G4 12V
 LED SMD: White +2 G4 LED for the eyes
 Electronic transformer and feed supply: 230V 12V in base
 Weight and measurements including packaging: 4 Kg - 350 x 260 x 1.130 mm

Figure: Aluminium
 Finition: Aluminium Coloré et Feuille Cuivre
 Tiges: Cuivre
 Ampoules: n° 4 Bispina 20W G4 12V
 LED SMD: Blancs + 2 LED G4 pour les yeux
 Transformateur et alimentation: électronique 230V 12V insérés dans la base
 Poids et mesure avec emballage: 4 Kg - 350 x 260 x 1.130 mm

Figura: Aluminio
 Acabado: Aluminio Coloreado y Hoja de Rame
 Tubos: Cobre
 Bombillas: n° 4 con doble enchufe 20W G4 12V
 LED SMD: Blancos + 2 LED G4 para los ojos
 Transformador y alimentador electrónico: 230V 12V introducidos en la base
 Peso y medidas con embalaje: 4 Kg - 350 x 260 x 1.130 mm

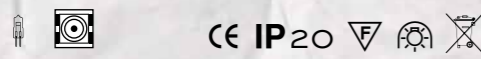

CODICE: AX 006



Figura: Alluminio
 Finitura: Tessuto Decorato e Applicazioni Varié
 Steli: Rame Cromato
 Lampadine: nr. 1 Halospot 50W 12V + 4 Bispina 20W G4 12V
 LED SMD: Rosso e Blu + 2 LED G4 per gli occhi
 Trasformatore e alimentatore elettronico: 230V 12V inseriti nella base
 Peso e misure con imballo: 4 Kg - 350 x 260 x 1.130 mm

Figure: Aluminium
 Finish: Decorated Fabric and Various Applications
 Stems: Chrome Copper
 Bulb: no. 1 Halospot 50W 12V + 4 Two-pin 20W G4 12V
 LED SMD: Red and Blue +2 G4 LED for the eyes
 Electronic transformer and feed supply: 230V 12V in base
 Weight and measurements including packaging: 4 Kg - 350 x 260 x 1.130 mm

Figure: Aluminium
 Finition: Tissu Décoré et Applications Variées
 Tiges: Cuivre Chromé
 Ampoules: n° 1 Halospot 50W 12V + 4 Bispina 20W G4 12V
 LED SMD: Rouge et Bleu + 2 LED G4 pour les yeux
 Transformateur et alimentation: électronique 230V 12V insérés dans la base
 Poids et mesure avec emballage: 4 Kg - 350 x 260 x 1.130 mm

Figura: Aluminio
 Acabado: Tejido Decorado y Varias Aplicaciones
 Tubos: Cobre Cromado
 Bombillas: n° 1 Halospot 50W 12V + 4 con enchufe doble 20W G4 12V
 LED SMD: Rojo y Azul + 2 LED G4 para los ojos
 Transformador y alimentador electrónico: 230V 12V introducidos en la base
 Peso y medidas con embalaje: 4 Kg - 350 x 260 x 1.130 mm



CODICE: AX 007



Figura: Alluminio
 Finitura: Tessuto Decorato + Pietre Rosse in Acrilico
 Steli: Rame Cromato
 Lampadine: nr. 4 Dicroiche 20W G4 12V
 LED SMD: 2 LED G4 per gli occhi
 Trasformatore e Alimentatore Elettronico: 230V 12V inseriti nella base
 Peso e misure con imballo: 4 Kg - 350 x 260 x 1.130 mm

Figure: Aluminium
 Finish: Decorated Fabric + Acrylic Red Stones
 Stems: Chrome Copper
 Bulb: no. 4 Dicroic 20W G4 12V
 LED SMD: 2 G4 LED for the eyes
 Electronic transformer and feed supply: 230V 12V in base
 Weight and measurements including packaging: 4 Kg - 350 x 260 x 1.130 mm

Figure: Aluminium
 Finition: Tissu Décoré + Pierres Rouges en Acrylique
 Tiges: Cuivre Chromé
 Ampoules: n° 4 Dicroiques 20W G4 12V
 LED SMD: 2 LED G4 pour les yeux
 Transformateur et alimentation: électronique 230V 12V insérés dans la base
 Poids et mesure avec emballage: 4 Kg - 350 x 260 x 1.130 mm

Figura: Aluminio
 Acabado: Tejido Decorado + Piedras Rojas de Acrílico
 Tubos: Cobre Cromado
 Bombillas: n° 4 Dicroicas 20W G4 12V
 LED SMD: 2 LED G4 para los ojos
 Transformador y alimentador electrónico: 230V 12V introducidos en la base
 Peso y medidas con embalaje: 4 Kg - 350 x 260 x 1.130 mm





Indiescreen - Brooklyn - N.Y.



Video Android



Cod. 7540 CR



Case Private
Private Houses



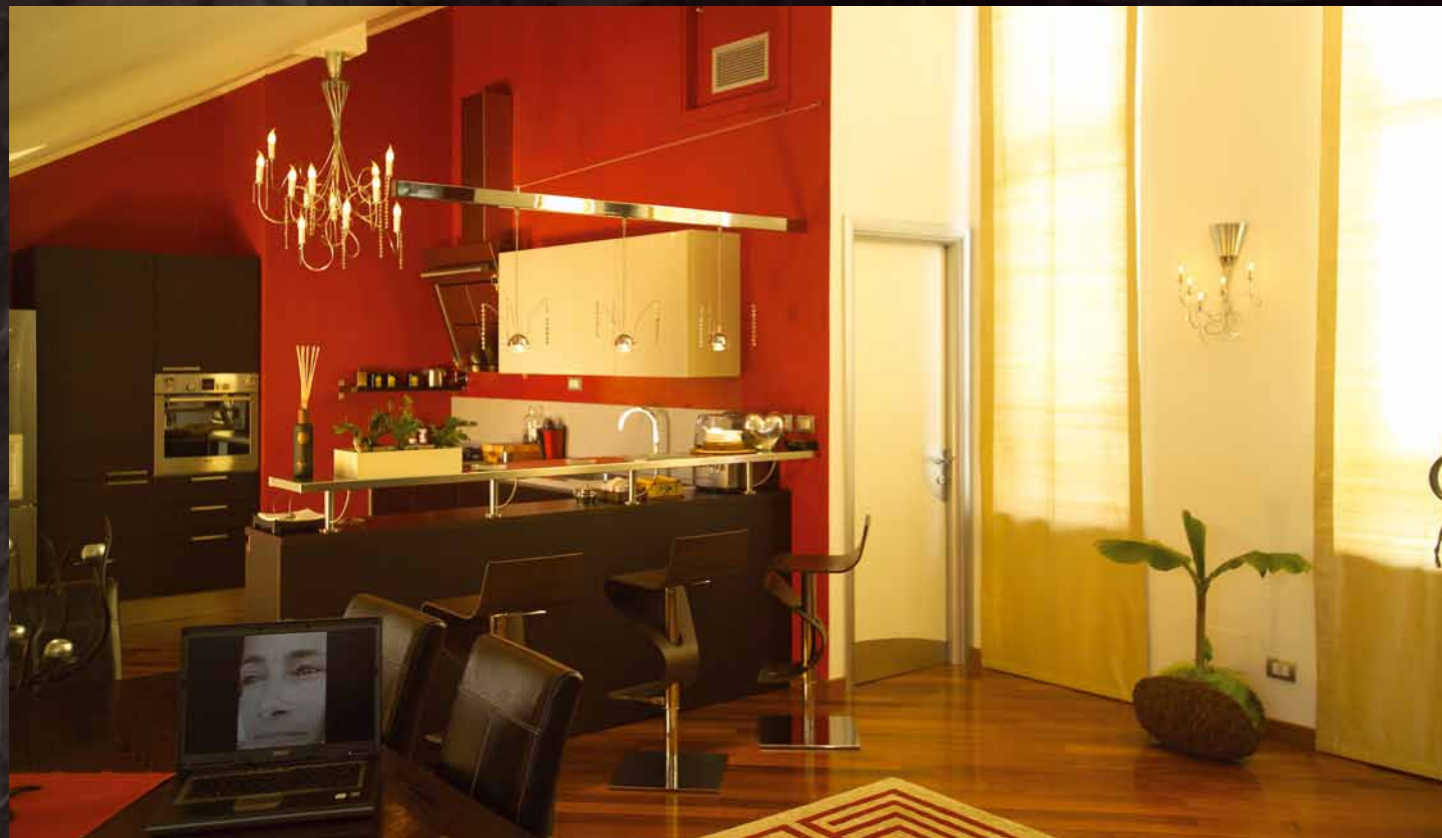

Lampadario Faal su misura
per il ristorante Tenuta Marchesi di Barolo
Barolo (CN) - Italia

Bespoke chandelier Faal ,
made for the restaurant
"Tenuta Marchesi di Barolo" Barolo (Cuneo) - Italy



Case Private
Private Houses





WRITER LED:

La luce quale emozione ha saputo trasmettere nel corso degli anni, la luce del sole ha illuminato la nostra vita, la luce della verità ha illuminato i nostri dubbi, la luce di un sorriso ha illuminato la nostra tristezza la luce del mattino ha illuminato i colori dei fiori.

Adesso Lucifero ha voluto rendere omaggio alla luce producendo una lampada che potesse dare emozione ad una stanca parete scrivendole una famosa frase di Edward Hopper: *"Quello che vorrei dipingere sulla parete di una casa è la luce del sole"*.

Grazie alla nuova tecnologia led ed un sistema di specchi posizionati alla parete possiamo dare vita e colore al nostro habitat.

Naturalmente la lampada Writer Led ci permette di poter personalizzare il testo secondo la propria esigenza e sensibilità.

Light, what a great emotion has transmitted us during years. Sunlight has lit up our life, the light of the truth lit up our doubts, the light of a smile illuminated our sadness, the light of the morning illuminated the colours of flowers.

At present, the Lucifero company has given a tribute to light by manufacturing a lamp which could give an emotion to a sad wall by writing on it the famous words of Edward Hopper *"What I would like to paint on the wall of a house is sunlight"*.

Thanks to the new led technology and to a system of mirrors put on the wall, we can give life and colour to our space of living. Obviously, the WRITER led lamp enables us to customize the written text following our exigencies and sensitivity.

La lumière, quelle grande émotion nous a transmis depuis des siècles. La lumière du soleil a éclairé notre vie, la lumière de la vérité a éclairé nos doutes, la lumière d'un sourire a éclairé notre affliction, la lumière du matin a éclairé les couleurs des fleurs.

A présent, l'entreprise Lucifero, a voulu rendre hommage à la lumière en produisant une lampe qui puisse porter sur un mur sombre une émotion, en citant les très fameuses mots de Edward Hopper: *«Ce que je voudrais peindre sur le mur d'une maison est la lumière du soleil»*.

Grâce à la nouvelle technologie à led et à un système des miroirs placés sur le mur, nous pouvons donner nouvelle vie et couleur à chaque endroit de notre maison.

Naturellement, la lampe Writer nous permet de personnaliser le texte écrit selon nos exigences et sensibilité.

La luz, que emoción ha sabido transmitir a lo largo de los años. La luz del sol ha iluminado nuestra vida, la luz de la verdad ha iluminado nuestras dudas, la luz de una sonrisa ha iluminado nuestra tristezza, la luz de la mañana ha iluminado los colores de las flores.

Ahora Lucifero ha querido rendir homenaje a la luz produciendo una lámpara que pudiera dar emoción a una cansada pared escribiendo una famosa frase di Edward Hopper *"lo que querría pintar en la pared de una casa es la luz del sol"*.

Gracias a la nueva tecnología led y a un sistema de espejos colocados en la pared podemos dar vida y color a nuestro hábitat.

Naturalmente la lámpara Writer led nos permite poder personalizar el texto según la propia exigencia y sensibilidad.



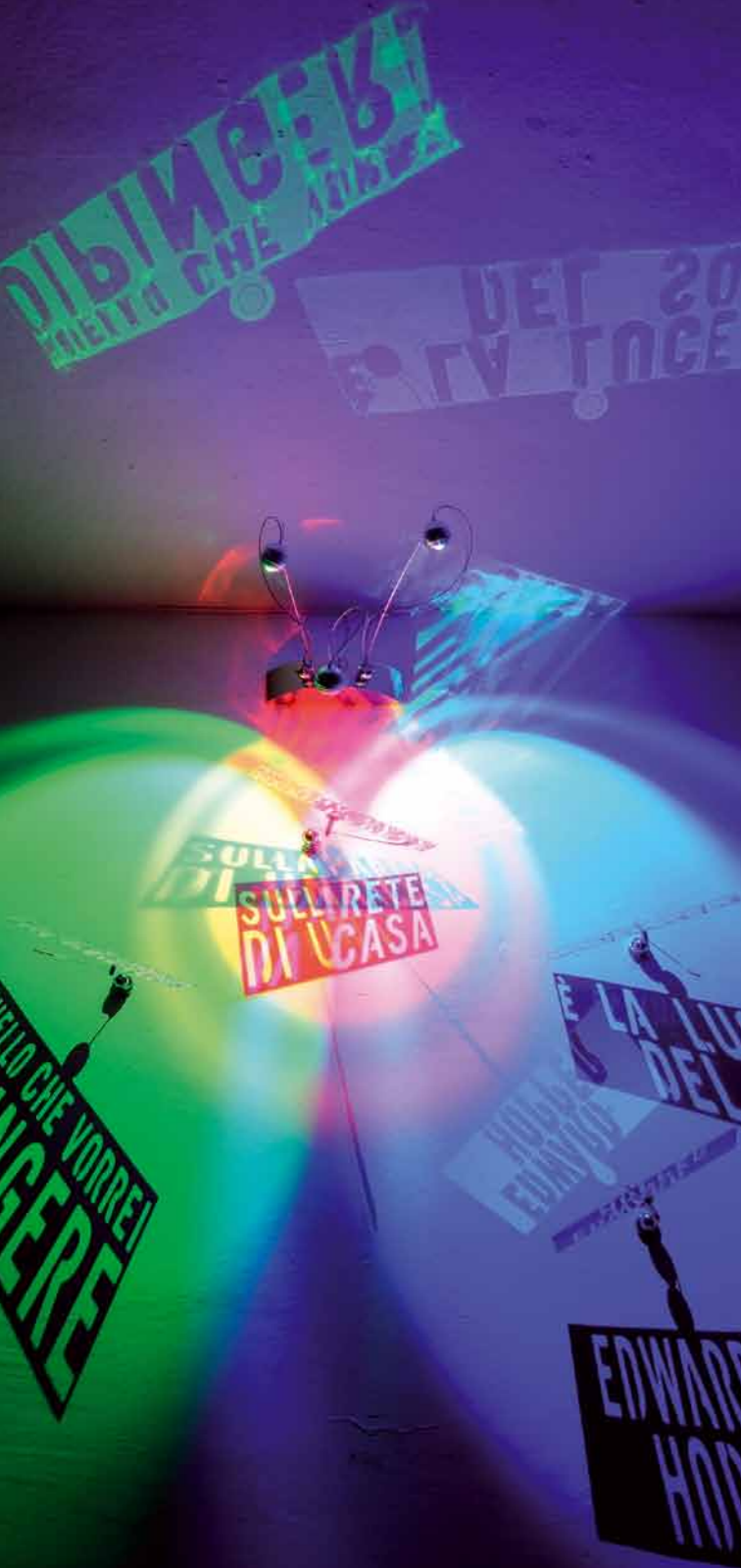

NEURON PROJECT

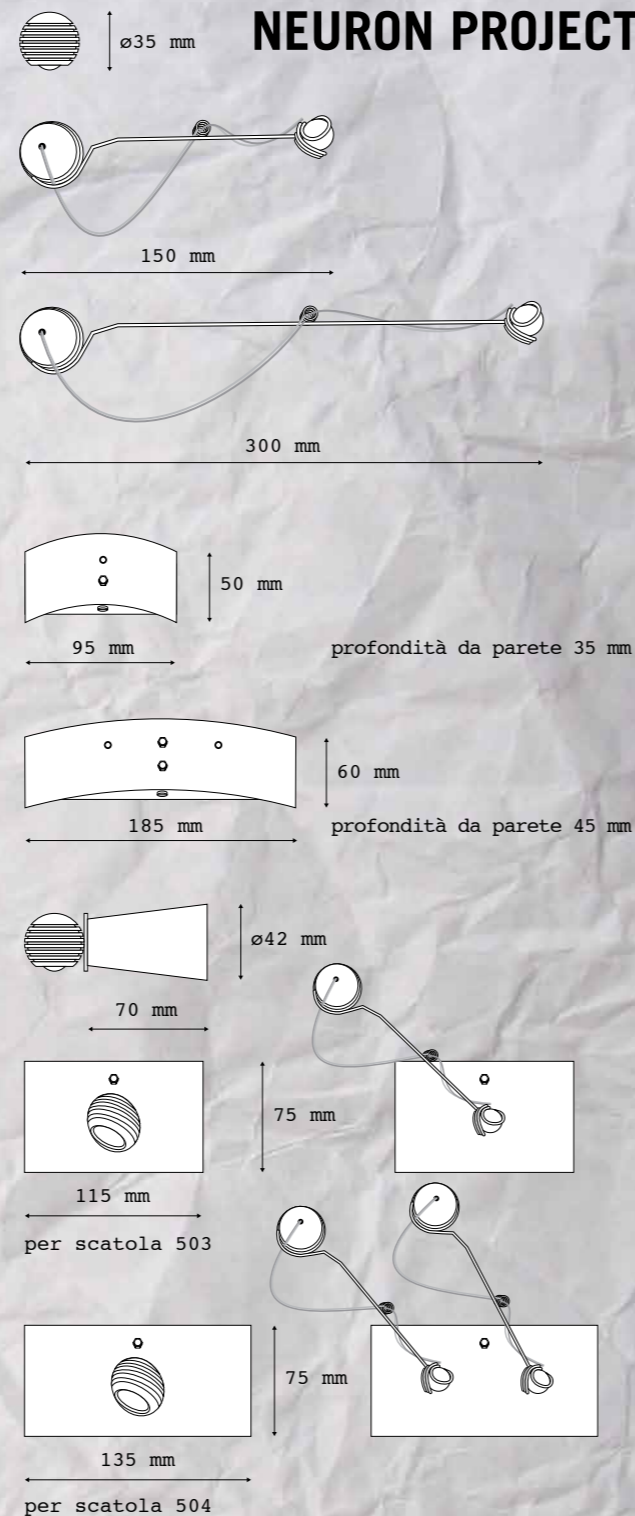

LEGENDA LED: Il progetto neurone utilizza led CREE e lenti Khatod

LED 1W necessita alimentazione 3,2V DC 350 mA
LED 3W necessita alimentazione 9,6V DC 350 mA

[C] = Calda, Warm 3.000° K - 107 LUMEN x WATT
[N] = Naturale, Natural 4.000° K - 114 LUMEN x WATT

Alimentazione: 220/240V 350 mA

Sfera in alluminio non trattata.

LEGENDA FINITURE:

(CR) Cromo
(RA) Rame
(RUG) Ruggine
(VB) Verniciatura Bianca
(VG) Verniciatura Grigia
(VNM) Verniciatura Nera Micacea
(ZB) Zincatura Bianca
(ZG) Zincatura Gialla



CODICE: NEU 001 1x1W [C] - CR NEU 001/3 1x3W [C] - CR
 NEU 001 1x1W [N] - CR NEU 001/3 1x3W [N] - CR

CE IP20
Base: Metallo
Finitura: Cromo (CR)
Opzioni: (VB), (VNM), (ZB), (ZG)
Sfera: Alluminio, Asta reggi sfera 150 mm (opzione 300 mm)
LED: 1 x 1W o 1 x 3W - Opticals 50°
Driver: 220/240V 350 mA inserito nella base
Peso e misure con imballo: 0,8 Kg - 210 x 150 x 200 mm



CODICE: NEU 003 3x1w [C] - CR NEU 003/3 3x3w [C] - CR
 NEU 003 3x1w [N] - CR NEU 003/3 3x3w [N] - CR

CE IP20
Base: Metallo
Finitura: Cromo (CR)
Opzioni: (VB), (VNM), (ZB), (ZG)
Sfera: Alluminio, Asta reggi sfera 150 mm (opzione 300 mm)
LED: 3 x 1W o 3 x 3W - Opticals 50°
Driver: 220/240V 350 mA inserito nella base
Peso e misure con imballo: 1 Kg - 400 x 290 x 112 mm



CODICE: NEU 002 2x1W [C] - CR NEU 002/3 2x3W [C] - CR
 NEU 002 2x1W [N] - CR NEU 002/3 2x3W [N] - CR

CE IP20
Base: Metallo
Finitura: Cromo (CR)
Opzioni: (VB), (VNM), (ZB), (ZG)
Sfera: Alluminio, Asta reggi sfera 300 mm (opzione 150 mm)
LED: 2 x 1W o 2 x 3W - Opticals 50°
Driver: 220/240V 350 mA inserito nella base
Peso e misure con imballo: 1 Kg - 400 x 290 x 112 mm



CODICE: NEU 004 1x1W [C] - CR NEU 004/3 1x3w [C] - CR
 NEU 004 1x1W [N] - CR NEU 004/3 1x3w [N] - CR

CE IP20
Base: Rame
Finitura: Cromo (CR)
Opzioni: (RA), (VB), (VNM), (ZB), (ZG)
Sfera: Alluminio
LED: 1 x 1W o 1 x 3W - Opticals 50°
Driver: non compreso (è consigliata alimentazione a 350 mA)
Peso e misure con imballo: 0,5 Kg - 210 x 150 x 200 mm

NEU 100 WL 3x1W CR

CE IP20

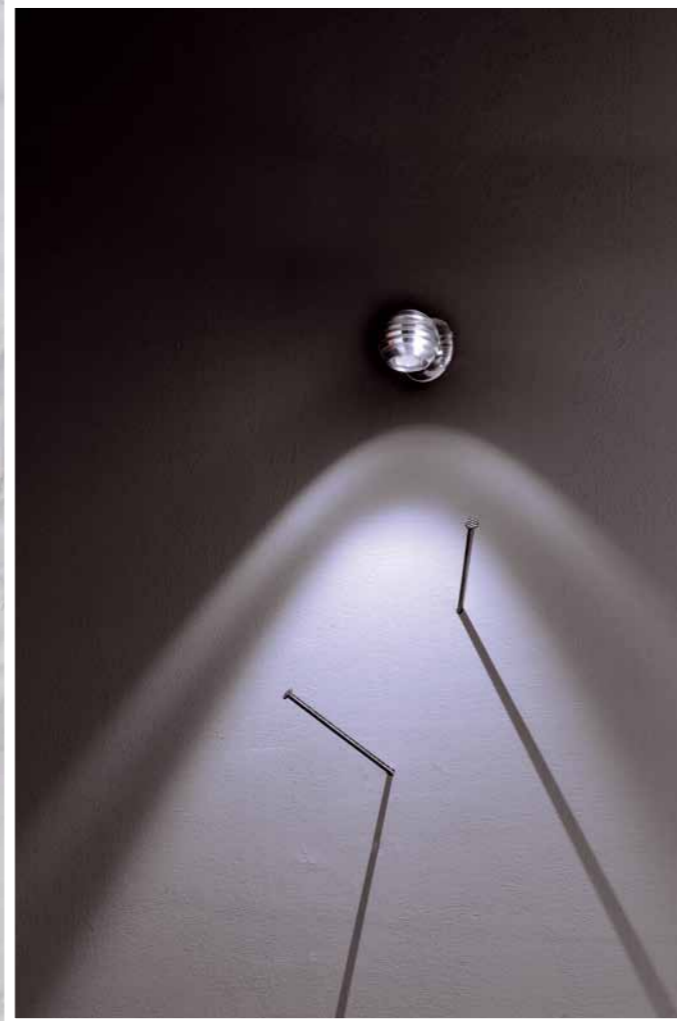

Finitura: Cromo (CR)
Opzioni: (VB), (VNM), (ZB), (ZG)
Sfera: Alluminio, Asta reggi sfera 300 mm
Particolarità: 4 Specchi acrilici con scritte intagliate
LED: 3x1W Rosso, Verde, Blu - Opticals 50°
Driver: 220/240V 350 mA inserito nella base
Peso e misure con imballo: 1,5 Kg - 400 x 290 x 112 mm

Personalizzazione: Specchi acrilici con scritte intagliate + 20%



CODICE: NEU 005 1x1W [C] - CR
NEU 005 1x1W [N] - CR

NEU 005/3 1x3W [C] - CR
NEU 005/3 1x3W [N] - CR

CE IP20   

Base: Metallo
Finitura: Cromo (CR)
Disco: Metallo ø 35 mm (foro ø 25 mm)
Sfera: Alluminio
Cavo: Trasparente 1.200 mm
LED: 1 x 1W o 1 x 3W - Opticals 50°
Driver: non compreso (è consigliata alimentazione a 350 mA)
Peso e misure con imballo: 0,10 Kg - 400 x 290 x 112 mm

LEGENDA LED:

LED 1W necessita alimentazione 3,2V DC 350 mA
LED 3W necessita alimentazione 9,6V DC 350 mA



[C] = Calda, Warm 3.000° K - 107 LUMEN x WATT
[N] = Naturale, Natural 4.000° K - 114 LUMEN x WATT

Alimentazione: 220/240V 350 mA

Sfera in alluminio non trattata.

CODICE: NEU 006 1x1W [C] - CR
NEU 006 1x1W [N] - CR

NEU 006/3 1x3W [C] - CR
NEU 006/3 1x3W [N] - CR

CE IP20   

Base: Metallo
Finitura: Cromo (CR)
Disco: Metallo ø 35 mm (foro ø 25 mm)
Sfera: Alluminio
LED: 1 x 1W o 1 x 3W - Opticals 50°
Driver: non compreso (è consigliata alimentazione a 350 mA)
Peso e misure con imballo: 0,06 Kg - 400 x 290 x 112 mm

COLLEGAMENTO LED 350 mA IN SERIE:

Nel collegamento in serie le tensioni di esercizio dei LED si sommano mentre la corrente erogata dal DRIVER non varia.

ESEMPIO:
Collegamento in serie di n. 2 LED 3W

3W=9,6V
2x3W=19,2V
Serve un DRIVER 220/240 min. 6W 20V 350 mA

COLLEGAMENTO LED 350 mA IN PARALLELO:



Nel collegamento in parallelo dei LED le tensioni di esercizio non variano, ma la corrente del DRIVER si dimezza.

ESEMPIO:
Collegamento in parallelo di n. 2 LED 3W

3W=9,6V
2x3W=9,6V
Serve un DRIVER 220/240 min. 6W 10V 700 mA

CODICE: NEU 007 1x1W [C] - CR
NEU 007 1x1W [N] - CR

NEU 007/3 1x3W [C] - CR
NEU 007/3 1x3W [N] - CR



CE IP20   

Base: Metallo
Finitura: Cromo (CR)
Disco: Metallo ø 35 mm (foro ø 25mm)
Sfera: Alluminio
LED: 1 x 1W o 1 x 3W - Opticals 50°
Driver: non compreso (è consigliata alimentazione a 350 mA)
Peso e misure con imballo: 0,06 Kg - 400 x 290 x 112 mm

CODICE: NEU 008 1x1W [C] - CR
NEU 008 1x1W [N] - CR

NEU 008/3 1x3W [C] - CR
NEU 008/3 1x3W [N] - CR

PER SCATOLA INCASSO 503 e 504

CE IP20   

Piastrina: Metallo 75 x 115 mm
Finitura: Cromo (CR)
Opzioni: (RA), (VB), (VG), (VNM), (ZB), (ZG)
Sfera: Alluminio orientabile
LED: 1 x 1W o 1 x 3W - Opticals 50°
Driver: non compreso (è consigliata alimentazione a 350 mA)
Peso e misure con imballo: 0,16 Kg - 400 x 290 x 112 mm

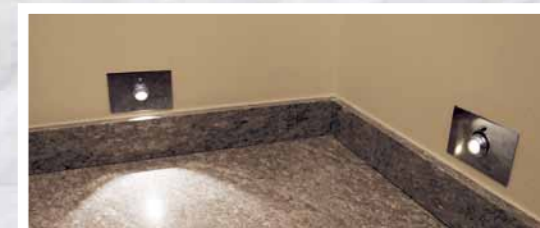

LUCIFERO

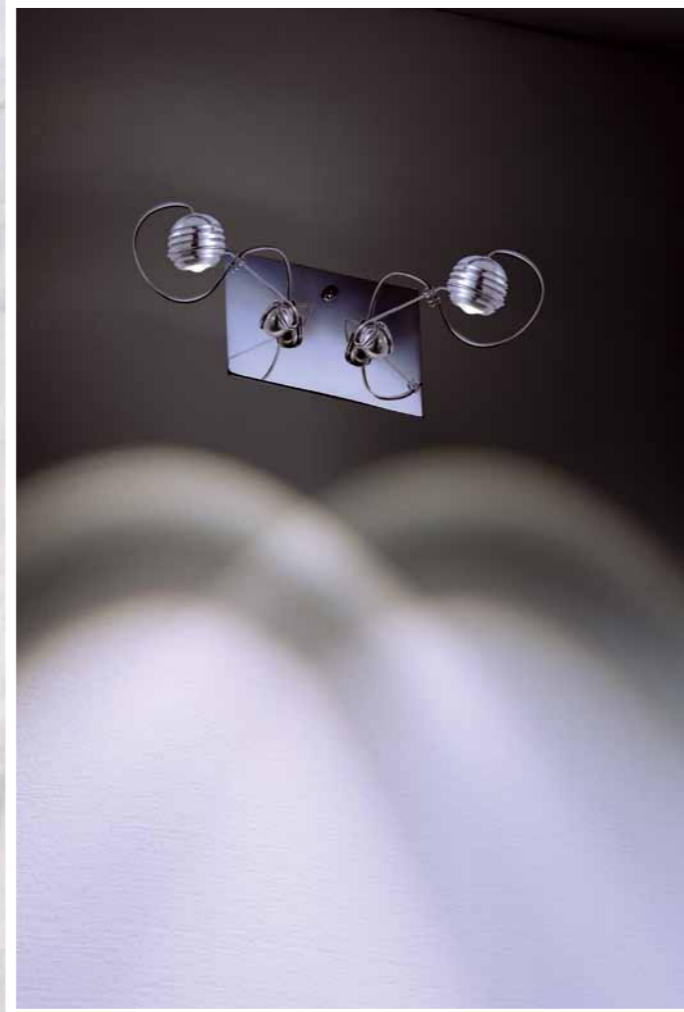

CODICE: NEU 009 1x1W [C] - CR
NEU 009 1x1W [N] - CR

NEU 009/3 1x3W [C] - CR
NEU 009/3 1x3W [N] - CR

CE IP20   

Disco: Metallo \varnothing 35 mm (foro \varnothing 25 mm)
Finitura: Cromo (CR)
Sfera: Alluminio, Asta reggi sfera 150 mm
LED: 1 x 1W o 1 x 3W - Opticals 50°
Driver: non compreso (è consigliata alimentazione a 350 mA)
Peso e misure con imballo: 0,11 Kg - 400 x 290 x 112 mm

CODICE: NEU 015 1x1W [C] - CR
NEU 015 1x1W [N] - CR

NEU 015 2x1W [C] - CR
NEU 015 2x1W [N] - CR



NEU 015 3x1W [C] - CR
NEU 015 3x1W [N] - CR

NEU 015/3 1x3W [C] - CR
NEU 015/3 1x3W [N] - CR

NEU 015/3 2x3W [C] - CR
NEU 015/3 2x3W [N] - CR

NEU 015/3 3x3W [C] - CR
NEU 015/3 3x3W [N] - CR

PER SCATOLA INCASSO 503 e 504

CE IP20   

Base: Metallo
Finitura: Cromo (CR)
Opzioni: (RA), (VB), (VG), (VNM), (ZB), (ZG)
Sfera: Alluminio, Asta reggi sfera 150 mm (opzione 300 mm)
LED: 2 x 1W o 2 x 3W - Opticals 50°
Driver: non compreso (è consigliata alimentazione a 350 mA)
Peso e misure con imballo: 0,20 Kg - 400 x 290 x 112 mm

LEGENDA LED:

LED 1W necessita alimentazione 3,2V DC 350 mA
LED 3W necessita alimentazione 9,6V DC 350 mA

[C] = Calda, Warm 3.000° K - 107 LUMEN x WATT
[N] = Naturale, Natural 4.000° K - 114 LUMEN x WATT

Alimentazione: 220/240V 350 mA

Sfera in alluminio non trattata.



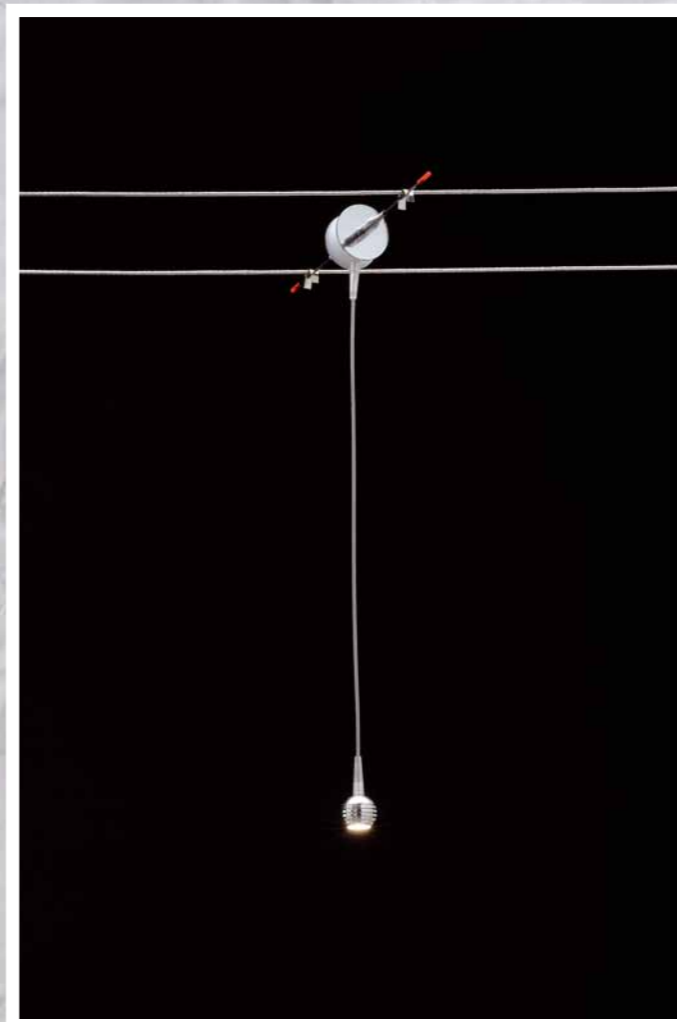
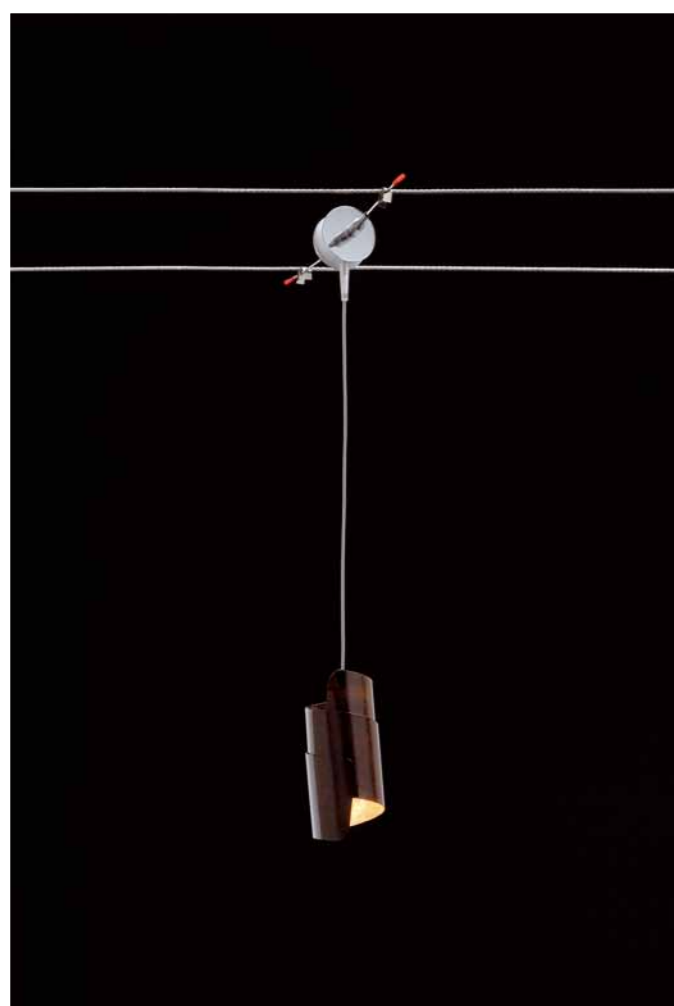

CODICE: NEU 010 1x3W [N] - RUG
NEU 010 1x3W [C] - RUG

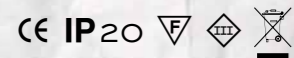

Cover: Metallo
Finitura: Ruggine (RUG)
Opzioni: (RA), (ZB), (ZG)
Cavo: Trasparente 1.200 mm
LED: 1 x 3W - Optical 50°
Stabilizzatore di corrente: 12V inserito nel corpo lampada

CODICE: NEU 011 1x3W [N]
NEU 011 1x3W [C]

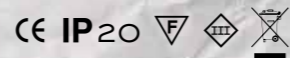

LED: 1 x 3W - Optical 50°
Stabilizzatore di corrente: 12V inserito nel corpo lampada

CODICE: NEU 012 1x3W [N]
NEU 012 1x3W [C]

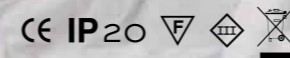

Cavo: Trasparente 1.200 mm
LED: 1 x 3W - Optical 50°
Stabilizzatore di corrente: 12V inserito nel corpo lampada

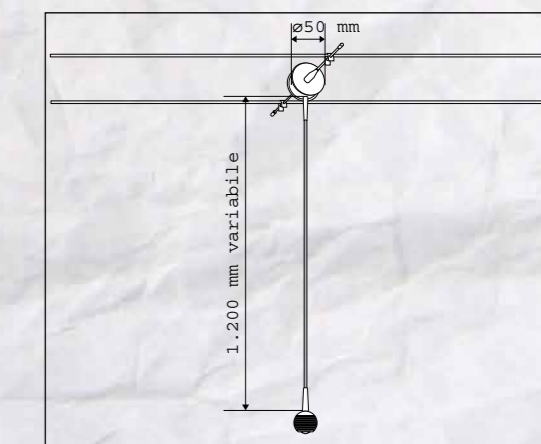
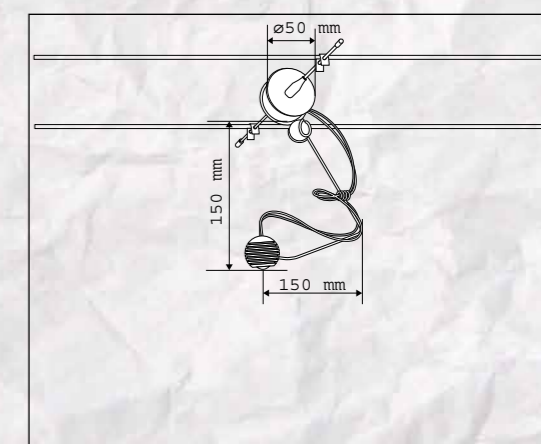
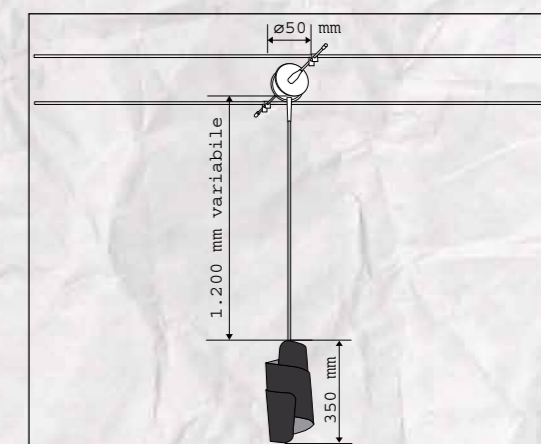

LEGENDA LED:

LED 1W necessita alimentazione 3,2V DC 350 mA
LED 3W necessita alimentazione 9,6V DC 350 mA

[C] = Calda, Warm 3.000° K - 107 LUMEN x WATT
[N] = Naturale, Natural 4.000° K - 114 LUMEN x WATT

Alimentazione: 220/240V 350 mA

Sfera in alluminio non trattata.

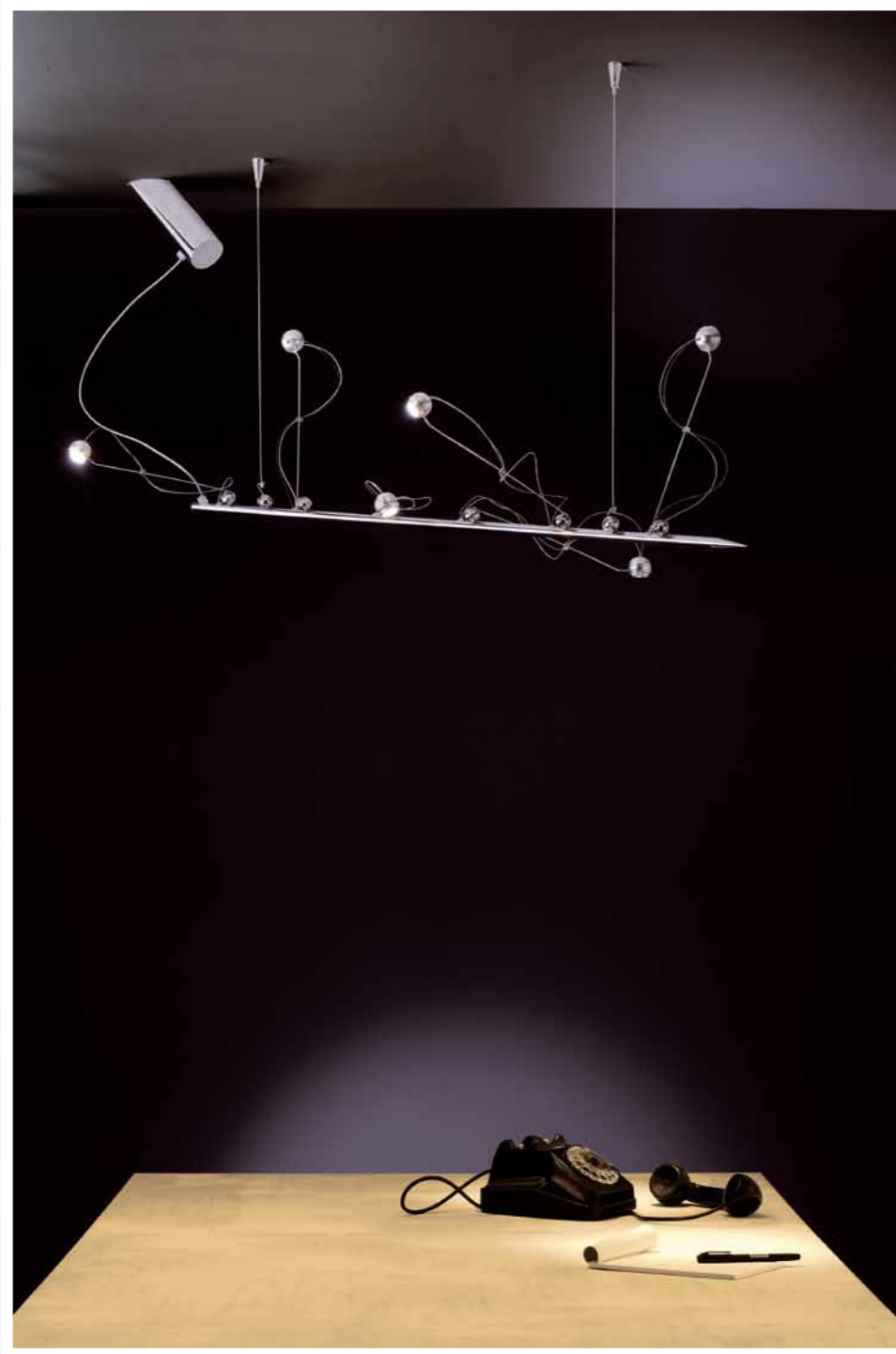

N.B.: il prodotto per tesata 12V deve essere alimentato solo con Trasformatore Toroidale o Elettromeccanico.



Harba

SOSPENSIONE

CODICE: NEU 013 6x3W [C] - CR
NEU 013 6x3W [N] - CR

CE IP20  

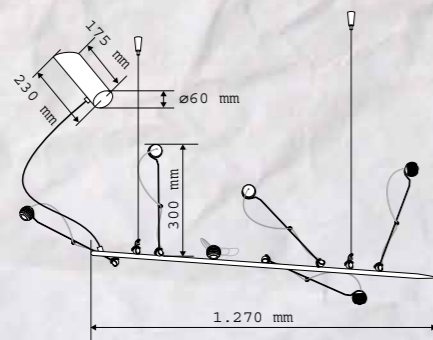

Base Cilindrica: Ottone
Finitura: Cromo (CR)
Opzioni: (VB), (VG), (VNM), (ZB), (ZG)
Sfere: Alluminio, Asta reggi sfera 300 mm
LED: 6 x 3 W - Opticals 50°
Driver: 220/240V 12V tensione costante, inserito nella base
Peso e misure con imballo: 3 Kg - 460 x 120 x 1.130 mm



Harba

PARETE

CODICE: NEU 014 6x3W [C] - CR
NEU 014 6x3W [N] - CR

CE IP20  

Base Cilindrica: Ottone
Finitura: Cromo (CR)
Opzioni: (VB), (VG), (VNM), (ZB), (ZG)
Sfere: Alluminio, Asta reggi sfera 300 mm
LED: 6 x 3 W - Opticals 50°
Driver: 220/240V 12V tensione costante, inserito nella base
Peso e misure con imballo: 3 Kg - 460 x 120 x 1.130 mm

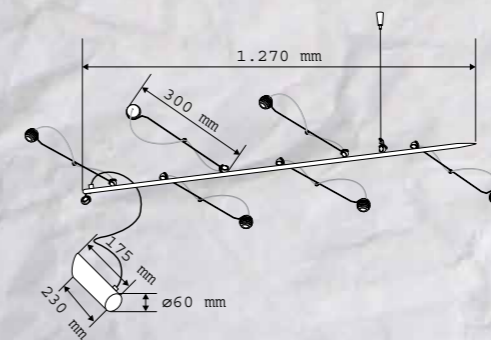



S I S T E M A T O T A M

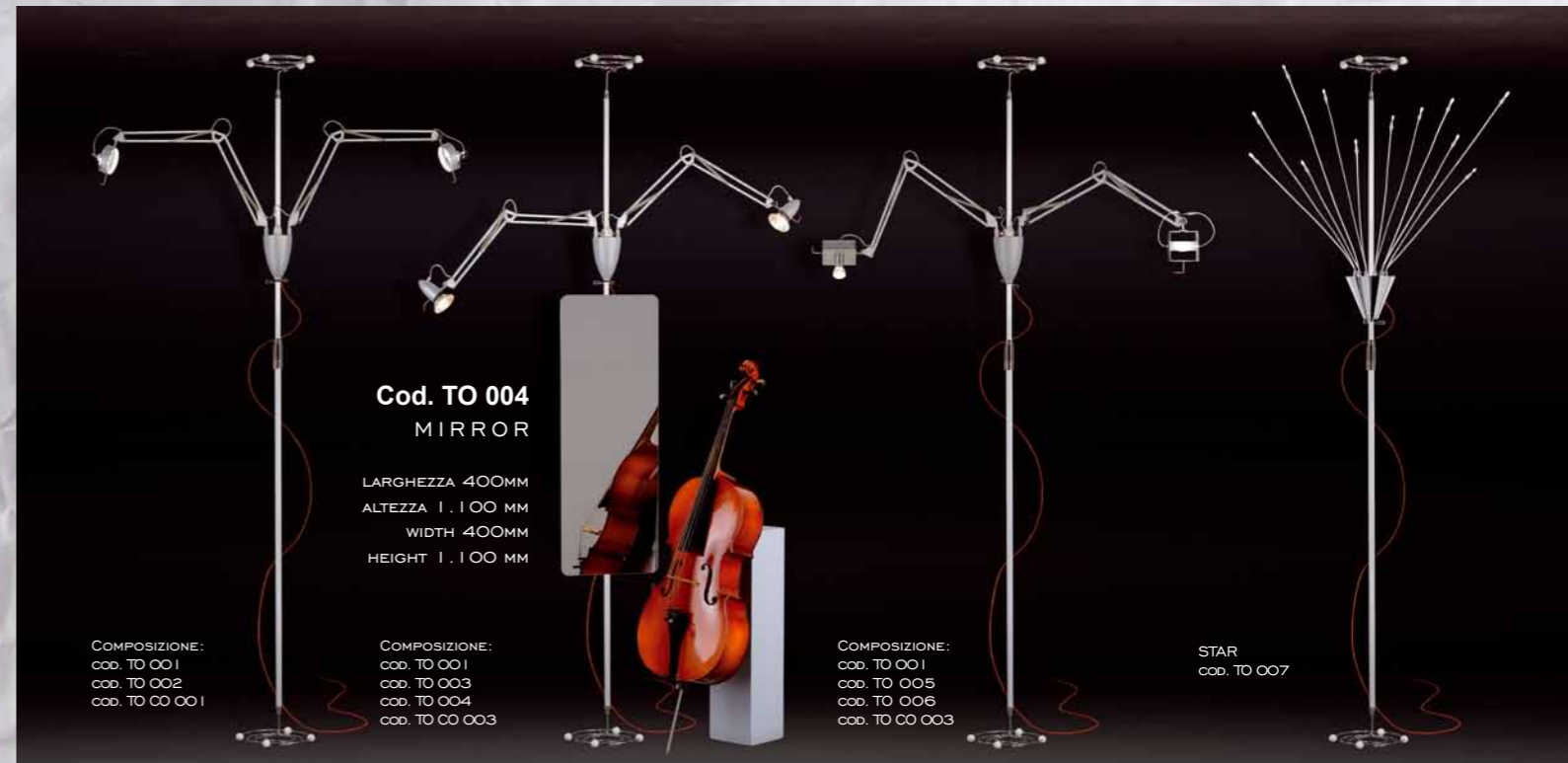
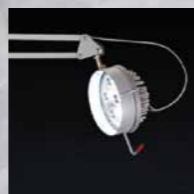
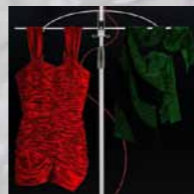
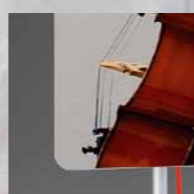
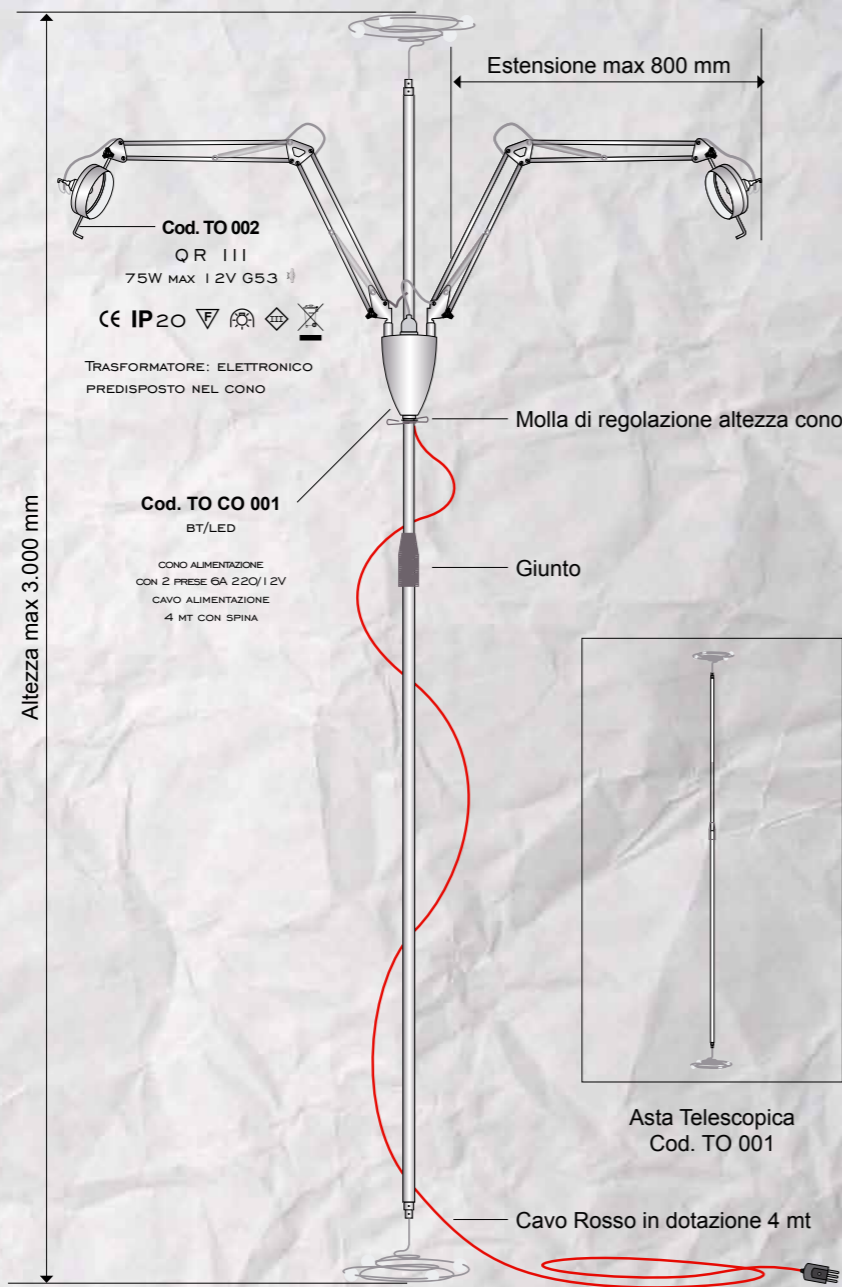

Cod. TO 004
MIRROR

LARGHEZZA 400MM
ALTEZZA 1.100 MM
WIDTH 400MM
HEIGHT 1.100 MM

COMPOSIZIONE:
cod. TO 001
cod. TO 002
cod. TO CO 001

COMPOSIZIONE:
cod. TO 001
cod. TO 003
cod. TO 004
cod. TO CO 003

COMPOSIZIONE:
cod. TO 001
cod. TO 005
cod. TO 006
cod. TO CO 003

STAR
cod. TO 007

S I S T E M A T O T A M



Cod. TO 002
QR III
75W MAX 12V G53

CE IP20

TRASFORMATORE: ELETTRONICO
PREDISPOSTO NEL CONO



Cod. TO 003
PAR
75W MAX E27 PAR 30
220-240V

CE IP20



Cod. TO CO 001
BT/LED
CONO ALIMENTAZIONE CON 2 PRESE 6A
CAVO ALIMENTAZIONE 4 MT CON SPINA
220-240V/12V

CE IP20



Cod. TO CO 003
CONO ALIMENTAZIONE CON 2 PRESE 10A
CAVO ALIMENTAZIONE 4 MT CON SPINA
220-240V

CE IP20



Cod. TO 005
JM
20W MAX GX10 220-240V

CE IP20

ALIMENTATORE ELETTRONICO
INSERITO NEL CORPO LAMPADA



Cod. TO 007
STAR
1 2X20W MAX G4 BISPINA
220-240V/12V

CE IP20

N.2 TRASFORMATORI ELETTRONICI
INSERITI NEL CONO

T O T A M S Y S T E M

TOTAM: una linea tra Terra e Cielo ...
Quando il passato si veste di nuovo.

TOTAM: a line between the Earth and
Sky... When the past dresses with the
new.

TOTAM: une ligne entre Terre et Ciel...
Quand le passé se remet à neuf

TOTAM: una línea entre la Tierra y el Cielo...
Cuando el pasado se viste de nuevo.

Lucifero presenta TOTAM:

Tra Arte e Design, Lucifero reinventa la Luce. Totam, il nuovo sistema componibile, pratico, leggero e veloce da montare, un sistema di illuminazione ibrido d'avanguardia che rivoluzionerà il modo di concepire la Luce.

Lucifero presents TOTAM:

Between Art and Design, Lucifero reinvents the Light. Totam, the new modular system, practical, lightweight and easy to mount, an avant-garde hybrid lighting system that revolutionize the way of the Light



VA NR
cod. TO 008

VA WHITE + TABLE
cod. TO 008/1
cod. TO 010

VA RN
cod. TO 008/2

CN BLACK
cod. TO 009

COMPOSIZIONE:
cod. TO 001
cod. TO 010
cod. TO 011
cod. TO 012

COMPOSIZIONE:
cod. TO 001
cod. TO 013
cod. TO 001

COMPOSIZIONE:
cod. TO 001
cod. TO 003
cod. TO 014
cod. TO 003

T O T A M S Y S T E M S I S T E M A T O T A M



Cod. TO 008
VA NR
3x23W E27 FBT
220-240V

CE IP20

CONO IN POLIPROPILENE



Cod. TO 008/2
VA RN
3x23W E27 FBT
220-240V

CE IP20

CONO IN POLIPROPILENE



Cod. TO 008/1
VA WHITE
3x23W E27 FBT
220-240V

CE IP20

CONO IN POLIPROPILENE

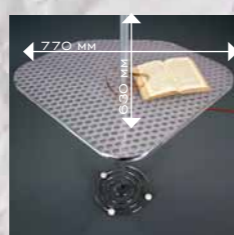

Cod. TO 010
TABLE
TAVOLO IN POLICARBONATO
TRASPARENTE
DIMENSIONI
LARGHEZZA 770 X 630 MM



Cod. TO 009
CN BLACK
2x23W E27 FBT
220-240V

CE IP20

CONO IN POLIPROPILENE

OPZIONE CODICE:

TO 009/1 (CN WHITE)
TO 009/2 (CN RED)



Cod. TO 011
STAF
STAFFA IN METALLO VERNI-
CIATO CON 2 PRESE 10A
220/240V E CAVO ALIMENTA-
ZIONE 4 MT CON SPINA PER
MONITOR LCD MAX 20"

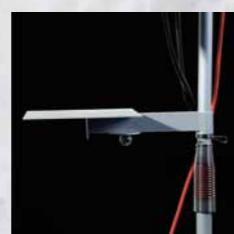

Cod. TO 012
BASE
BASE PER PLAYER MULTIMEDIA-
LE O LETTORE DVD IN METALLO
VERNICIATO



Cod. TO 013
LED
LED 9W 350MA (6.000°K)

CE IP20

ALIMENTATORE PREDISPOSTO NEL CONO



Cod. TO 003
PAR
75W MAX E27 PAR 30

CE IP20

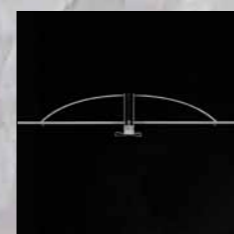

Cod. TO 014
APP
APPENDIABILI

Opzioni per Cono a 4 prese:



Cod. TO CO 002
BT/LED
CONO ALIMENTAZIONE CON 4 PRESE 6A
CAVO ALIMENTAZIONE 4 MT CON SPINA
220-240/12V

CE IP20

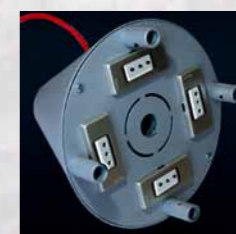

Cod. TO CO 004
CONO ALIMENTAZIONE CON 4 PRESE 10A
CAVO ALIMENTAZIONE 4 MT CON SPINA
220-240V

CE IP20

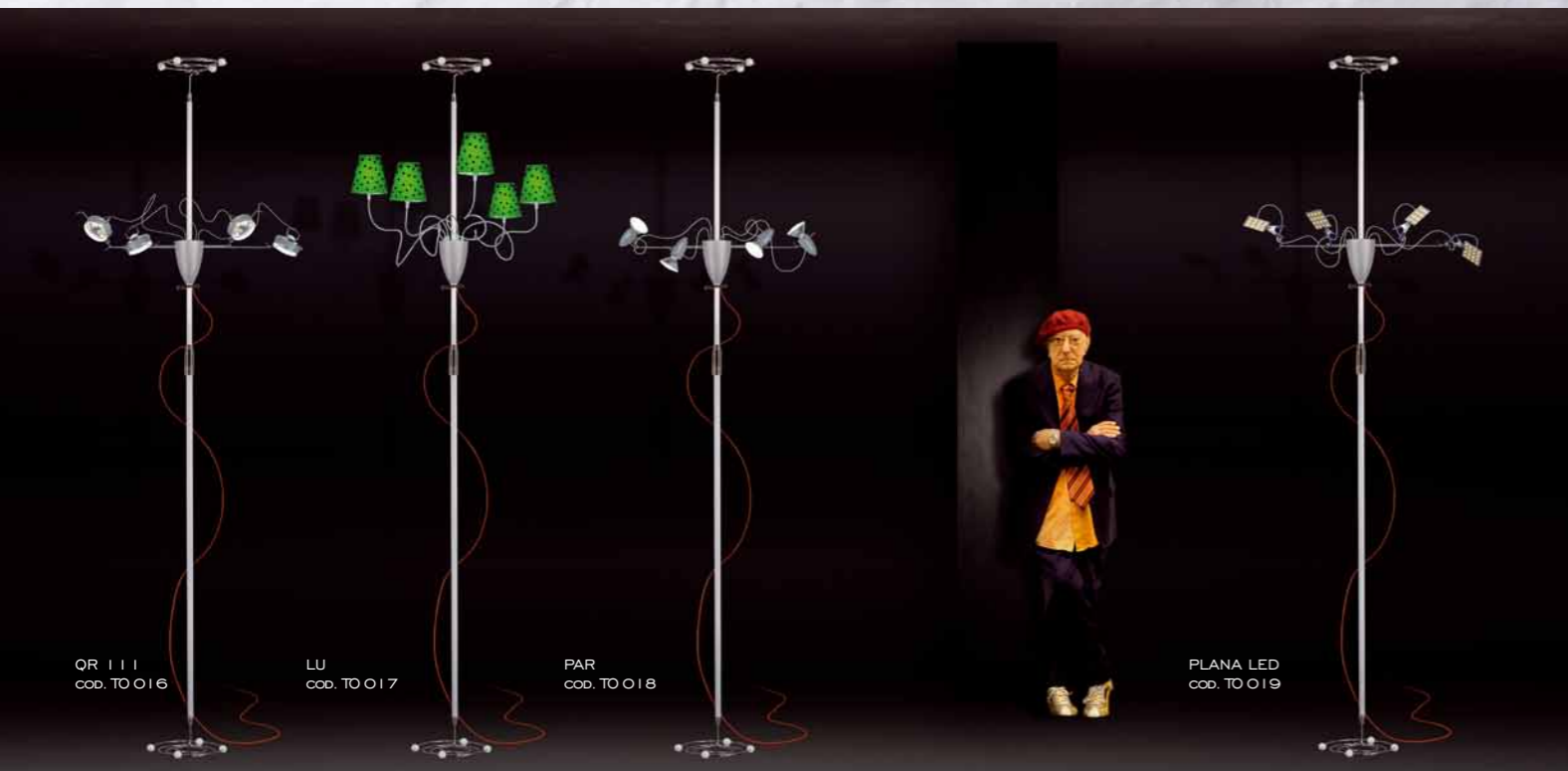

SISTEMA CAVI BASSA TENSIONE 12V

NOTA BENE:
il prodotto per tesata 12V deve essere alimentato solo con Trasformatore Toroidale o Elettromeccanico.

Su tutti i nostri prodotti in bassa tensione 12V (con trasformatore elettronico, elettromeccanico o toroidale) non è consigliato l'uso di potenziometri o variatori. Si raccomanda inoltre su tutti i prodotti in bassa tensione 12V (es. tesate, applique) di controllare periodicamente i punti di contatto ed eventualmente serrarli, col tempo la dilatazione termica può determinare un allentamento delle viti.



T O T A M S Y S T E M



Cod. TO 016

QR 111
4 x 75W MAX 12V
G53 220-240V

CE IP20

TRASFORMATORI ELETTRONICI
INSERITI NEL CONO



Cod. TO 017

LU
5 x 40W MAX E14
220-240V

CE IP20

OPZIONE COLORE:
RED, GREEN, BLUE, YELLOW



Cod. TO 018

PAR
4 x 75W MAX E27 PAR 30
220-240V

CE IP20

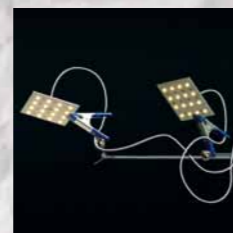

Cod. TO 019

PLANA LED
4 x 11W 12V (3.000°K)
220-240V

CE IP20

TRASFORMATORE TOROIDALE
INSERITO NEL CONO

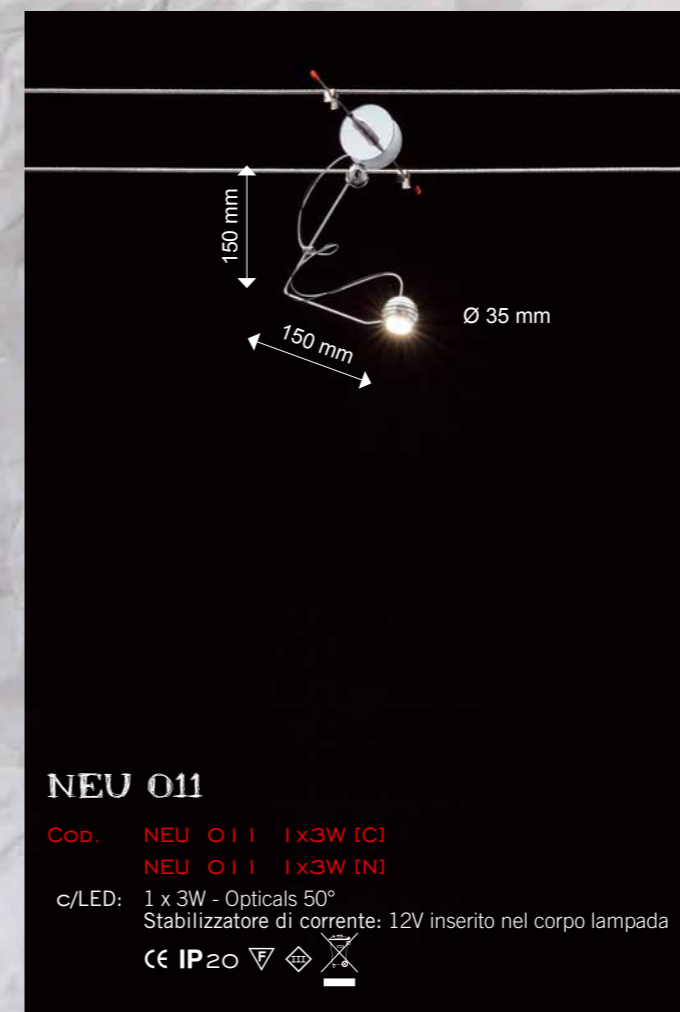

Video Totam



LEDAIR
 Cod. 2500 LED (C) 3.000° K
 Cod. 2500 LED (N) 4.000° K

LED | 1W | 12V | CE | IP20

NATRIX NATRIX
 Cod. 3503 LT

C/DICROICA 50W | 12V Ø5 | GU5,3 | CE | IP20

ESOX LUCIUS
 Cod. 3506 LT

C/DICROICA 50W | 12V Ø5 | GU5,3 | CE | IP20

LAMPRIS
 Cod. 3504 LT

C/DICROICA 50W | 12V Ø5 | GU5,3 | CE | IP20

BELONE BELONE
 Cod. 3505 LT

C/DICROICA 50W | 12V Ø5 | GU5,3 | CE | IP20

PAGURUS BERNHARDUS
 Cod. 3502 LT

C/DICROICA 50W | 12V Ø5 | GU5,3 | CE | IP20

CONGER CONGER
 Cod. 3501 LT

C/DICROICA 50W | 12V Ø5 | GU5,3 | CE | IP20

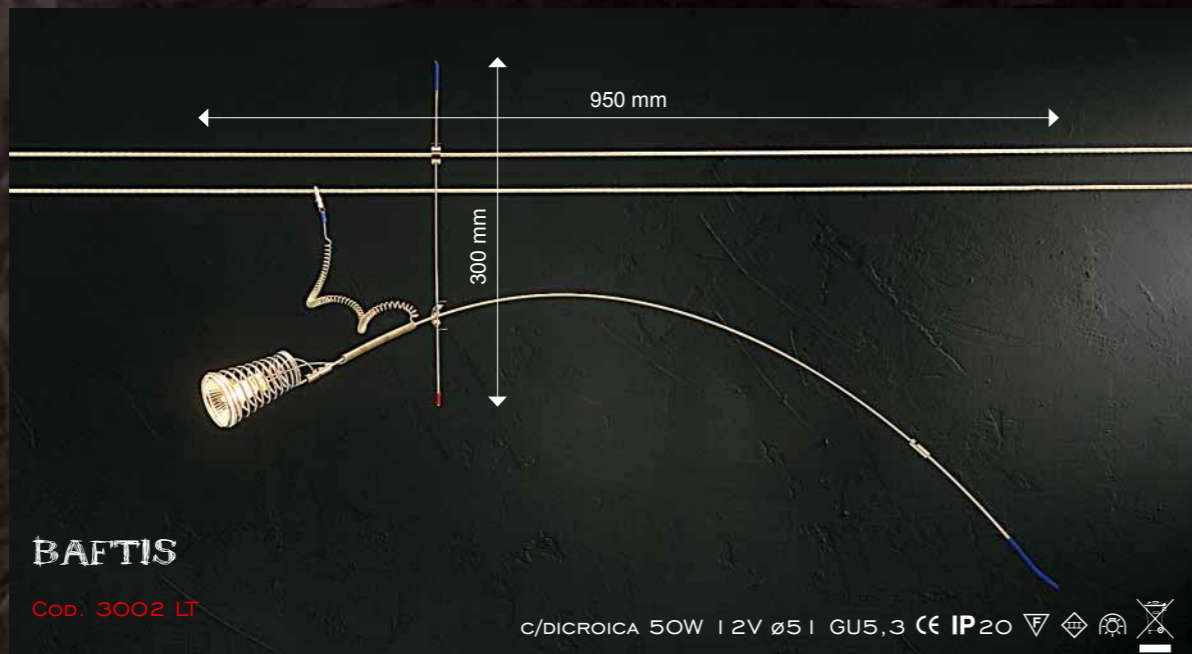

BAFTIS

Cod. 3002 LT

C/DICROICA 50W | 2V ø5 | GU5,3 CE IP20



NETHOS

Cod. 3008 LT

C/DICROICA
50W | 2V ø5 |
GU5,3

CE IP20

SPIRITELLO

Cod. 3601 LT

C/DICROICA
50W | 2V ø5 |
GU5,3

CE IP20



DARDA

Cod. 3010 LT

C/DICROICA 50W | 2V ø5 | GU5,3 CE IP20

Lunghezza cavo 1.300 mm



LUCIOCCHIO

Cod. 3602 LT AR

C/DICROICA 50W | 2V ø5 | GU6,35 CE IP20

distanza cavi 350 mm

Ø 125 mm

360 mm



EBRON

Cod. 2997 LT

C/DICROICA 50W | 2V ø5 | GU5,3 CE IP20



DAGON

Cod. 3006 LT

C/DICROICA 50W | 2V ø5 | GU5,3 CE IP20

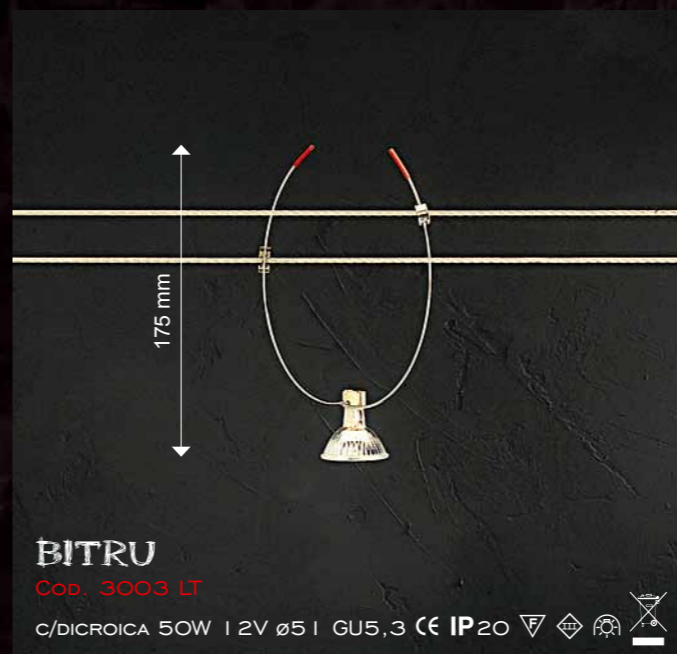

BITRU

Cod. 3003 LT

C/DICROICA 50W | 2V ø5 | GU5,3 CE IP20

175 mm

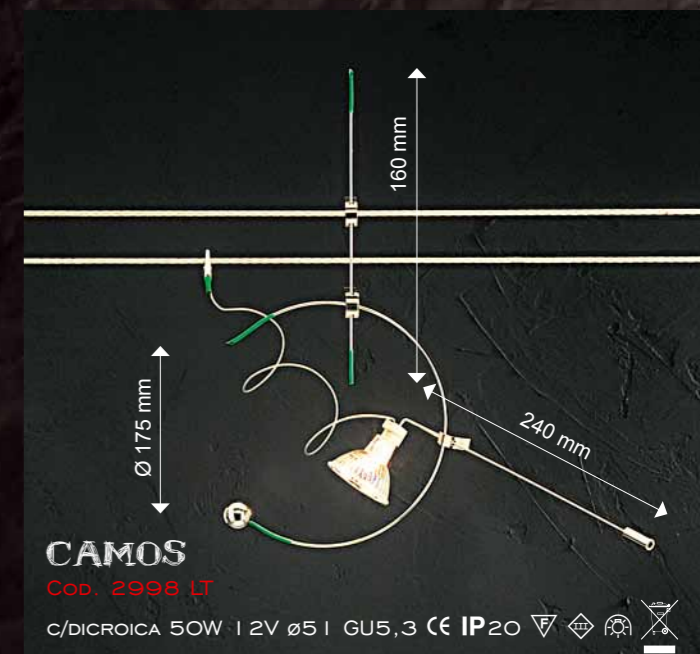

CAMOS

Cod. 2998 LT

C/DICROICA 50W | 2V ø5 | GU5,3 CE IP20

Ø 175 mm

160 mm

240 mm

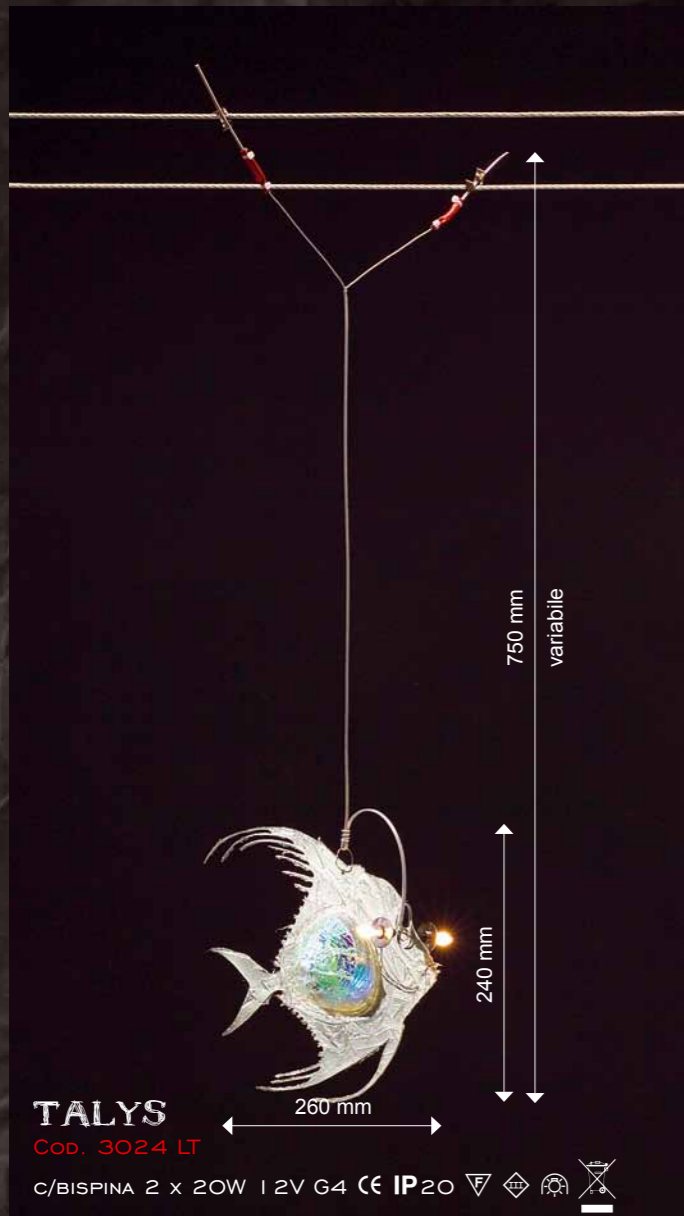

TALYS
Cod. 3024 LT

C/BISPINA 2 x 20W | 2V G4 **IP20**

750 mm
variabile

240 mm

260 mm



OES
Cod. 3025 LT

C/BISPINA 5 x 10W G4 | 2V **IP20**

1.000 mm
variabile

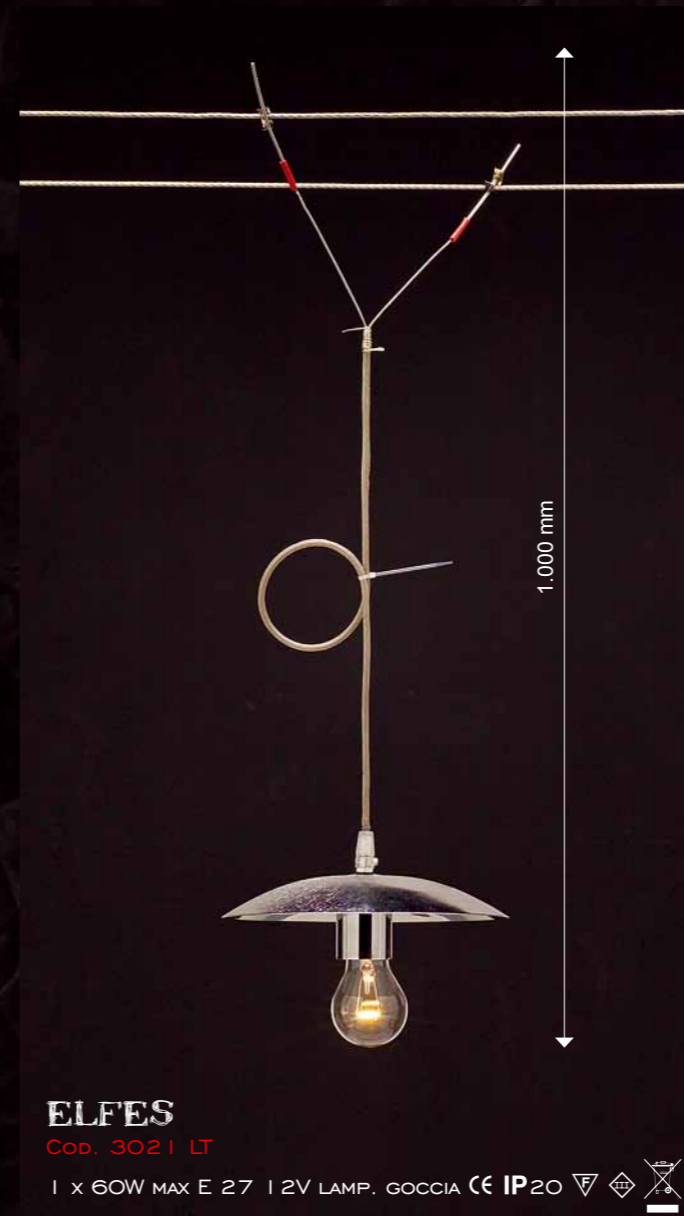

ELFES
Cod. 3021 LT

1 x 60W MAX E 27 | 2V LAMP. GOCCIA **IP20**

1.000 mm



SALEH
Cod. 3020 LT

1 x 60W MAX E 27 | 2V LAMP. GOCCIA **IP20**

1.200 mm

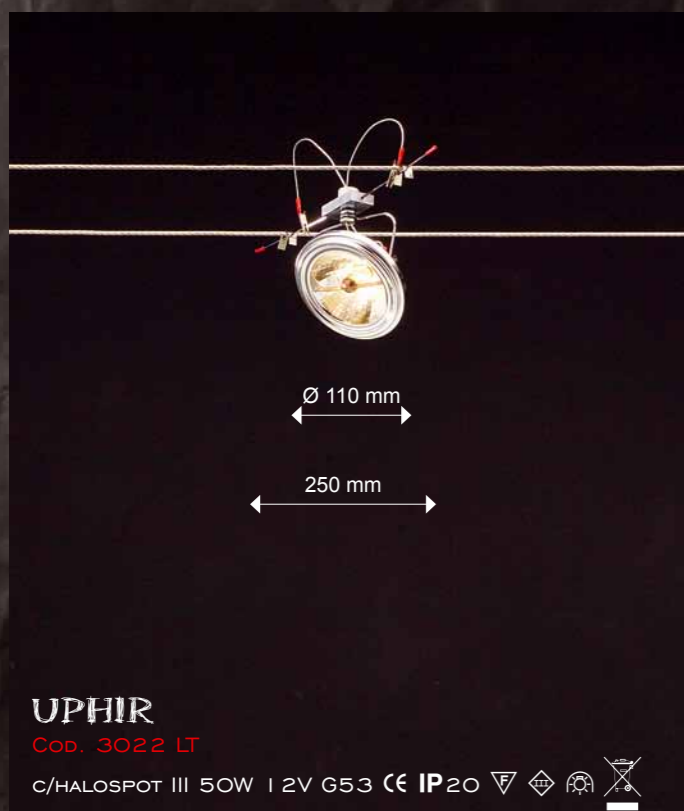

UPHIR
Cod. 3022 LT

C/HALOSPOT III 50W | 2V G53 **IP20**

Ø 110 mm

250 mm

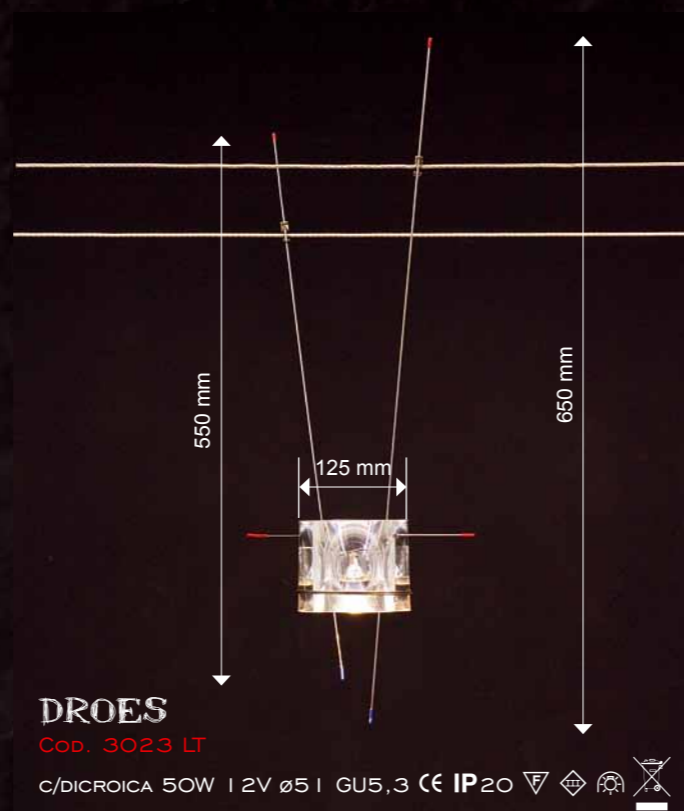

DROES
Cod. 3023 LT

C/DICROICA 50W | 2V Ø51 GU5,3 **IP20**

550 mm

125 mm

650 mm



HEBEN
Cod. 3018 LT

C/HALOSPOT III 50W | 2V G53 **IP20**

500 mm



NIHA
Cod. 3019 LT

1 x 60W MAX E 27 | 2V LAMP. GOCCIA **IP20**

200 mm

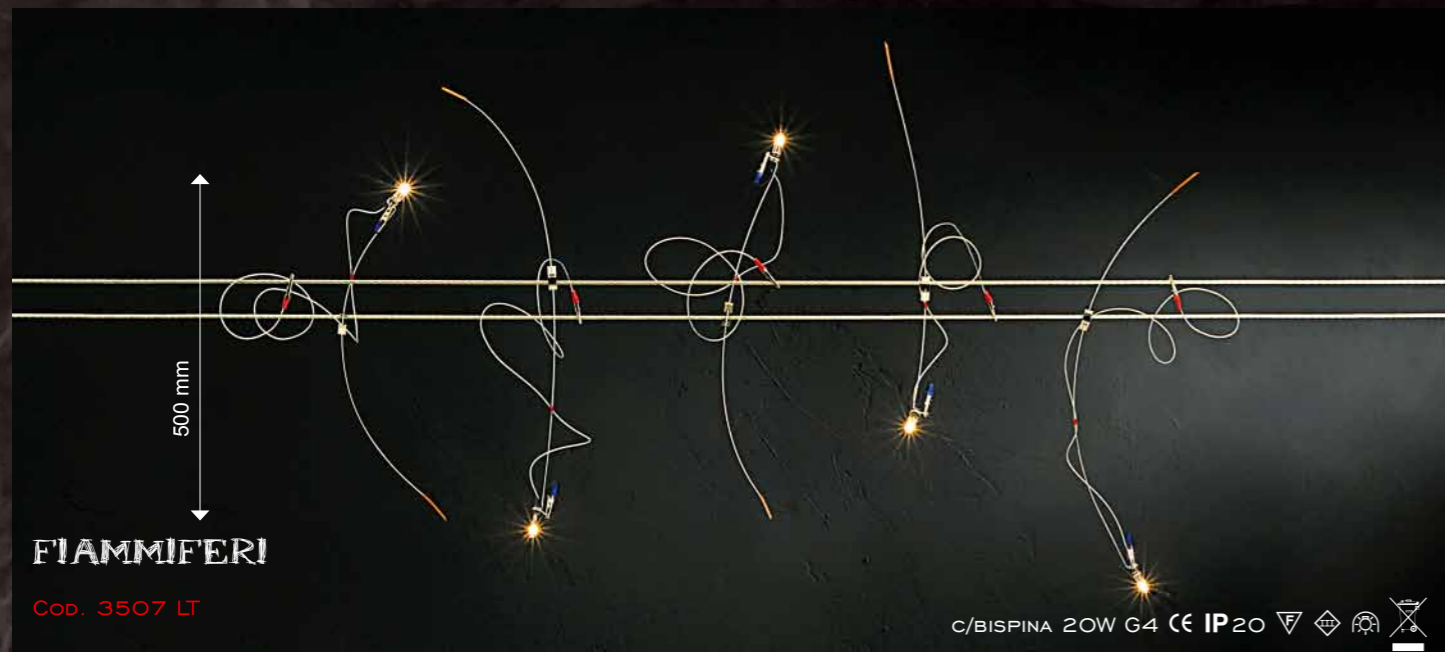

FIAMMIFERI

Cod. 3507 LT

C/BISPINA 20W G4 CE IP20

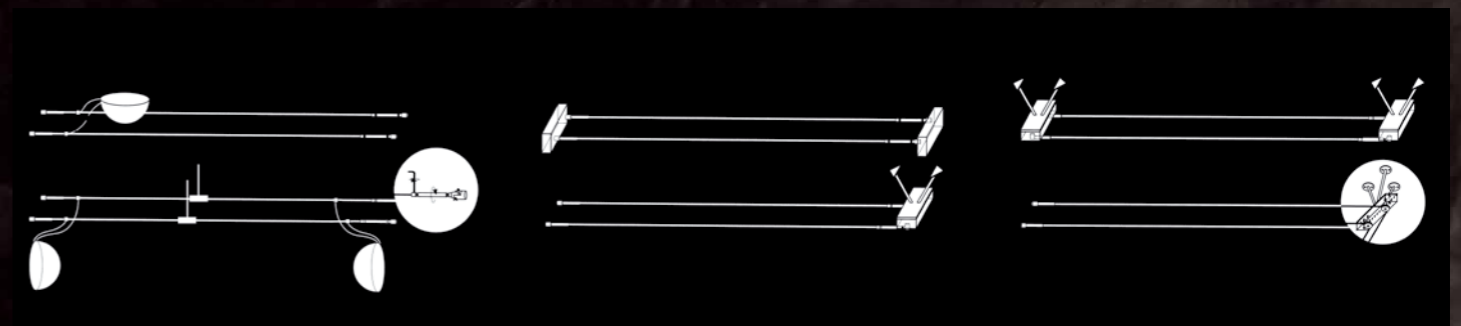

COMPONENTI PER SISTEMA BASSA TENSIONE 12V

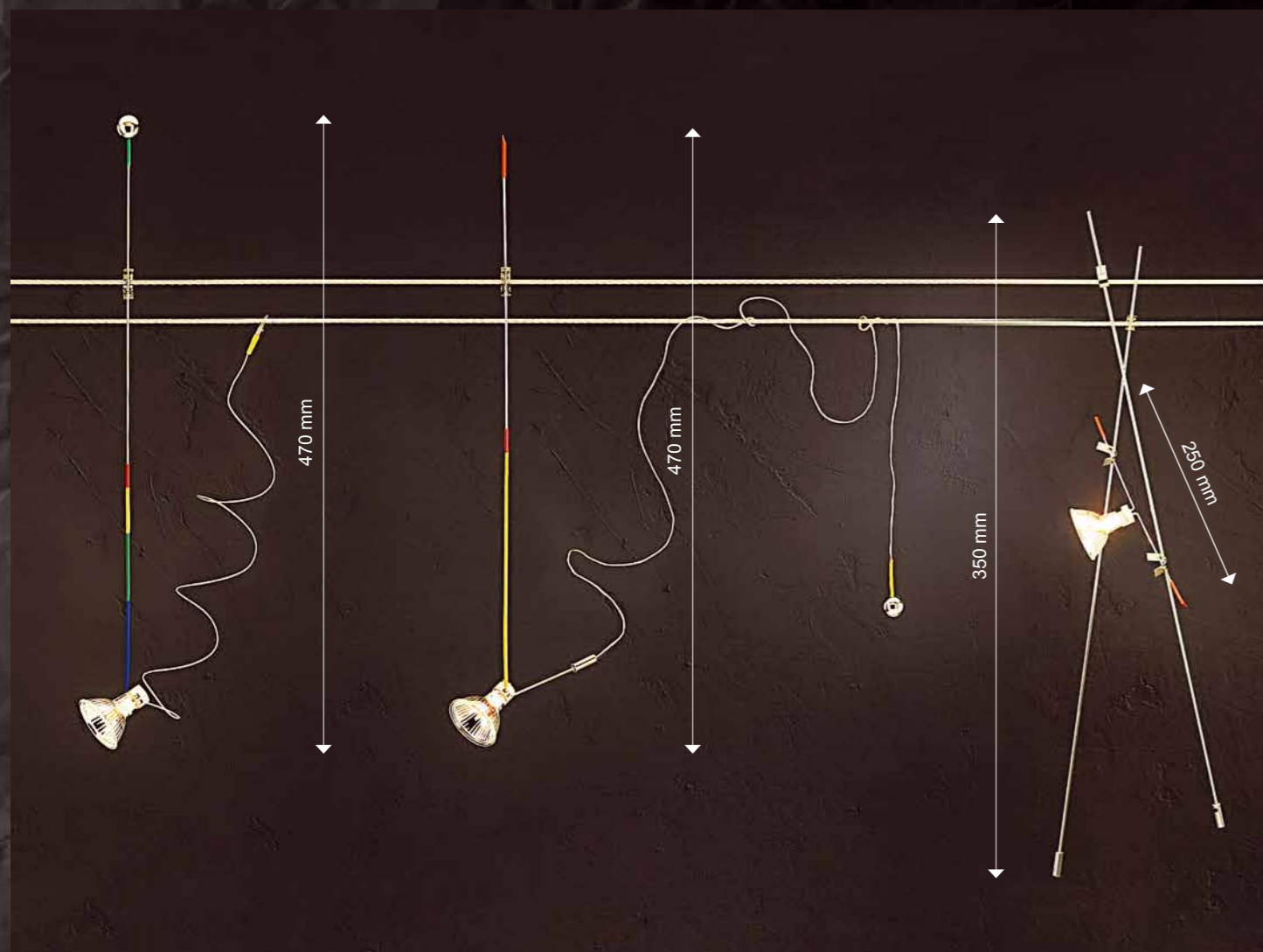

GERION

Cod. 3005 LT

C/DICROICA
50W 12V ø5 I
GU5,3



CAHOR

Cod. 3004 LT

C/DICROICA
50W 12V ø5 I
GU5,3



ZEPAR

Cod. 3000 LT

C/DICROICA
50W 12V ø5 I
GU5,3

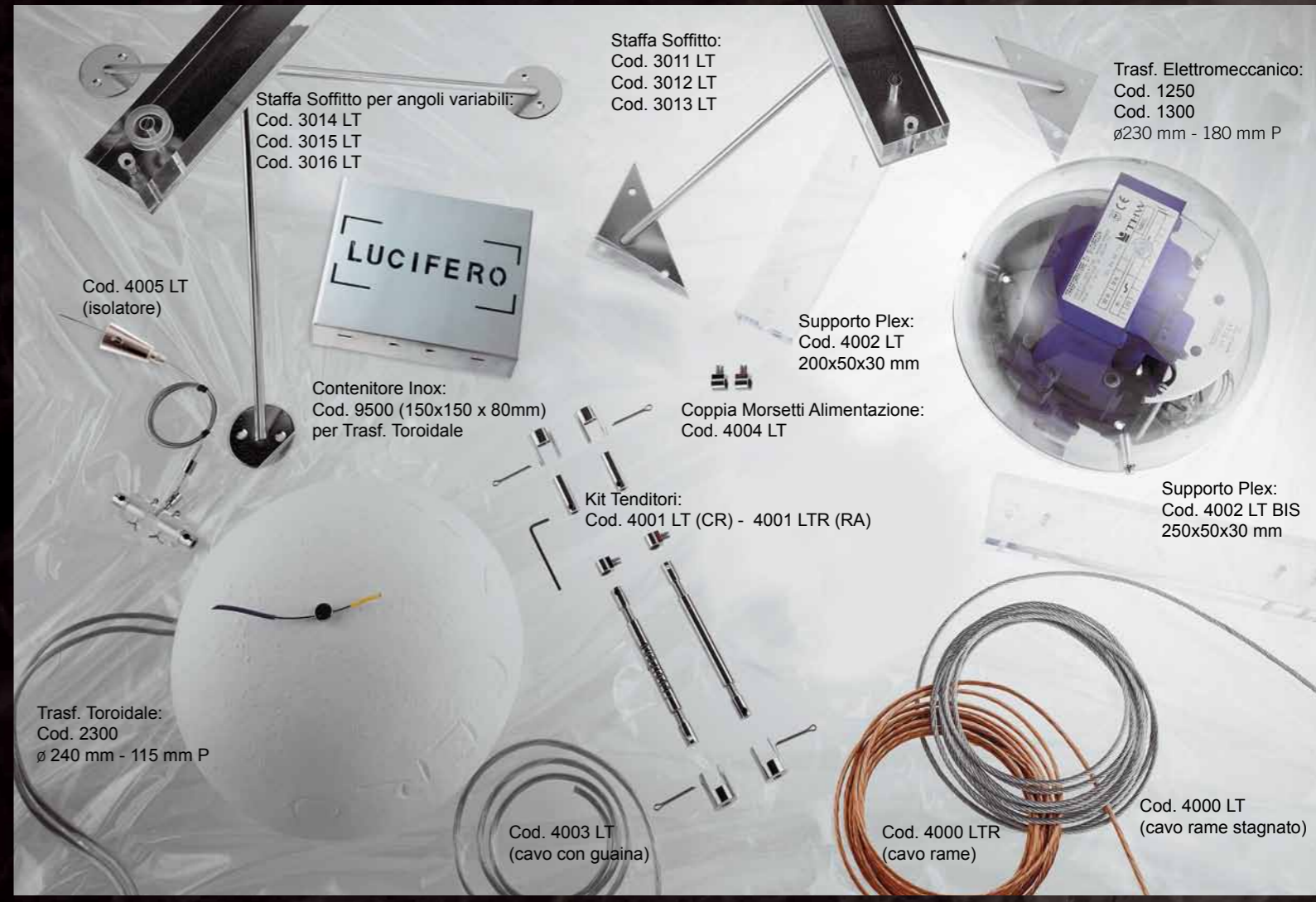

- Staffa Soffitto: Cod. 3011 LT, Cod. 3012 LT, Cod. 3013 LT
- Staffa Soffitto per angoli variabili: Cod. 3014 LT, Cod. 3015 LT, Cod. 3016 LT
- Trasf. Elettromeccanico: Cod. 1250, Cod. 1300 (ø230 mm - 180 mm P)
- Trasf. Toroidale: Cod. 2300 (ø 240 mm - 115 mm P)
- Contenitore Inox: Cod. 9500 (150x150 x 80mm) per Trasf. Toroidale
- Supporto Plex: Cod. 4002 LT (200x50x30 mm), Cod. 4002 LT BIS (250x50x30 mm)
- Coppia Morsetti Alimentazione: Cod. 4004 LT
- Kit Tenditori: Cod. 4001 LT (CR) - 4001 LTR (RA)
- Cod. 4005 LT (isolatore)
- Cod. 4003 LT (cavo con guaina)
- Cod. 4000 LTR (cavo rame)
- Cod. 4000 LT (cavo rame stagnato)

NOTA BENE:

Su tutti i nostri prodotti in bassa tensione 12V (con trasformatore elettronico, elettromeccanico o toroidale) non è consigliato l'uso di potenziometri o variatori. Si raccomanda inoltre su tutti i prodotti in bassa tensione 12V (es. tesate, applique) di controllare periodicamente i punti di contatto ed eventualmente serrarli, col tempo la dilatazione termica può determinare un allentamento delle viti.



SISTEMA COLOMBO 220/240V

COLOMBO SYSTEM 220/240V



CAVO ALIMENTAZIONE
LINE CORD

OVO PRELEVA TENSIONE
FEEDING EGG

CAVI ACCIAIO
STEEL CABLE



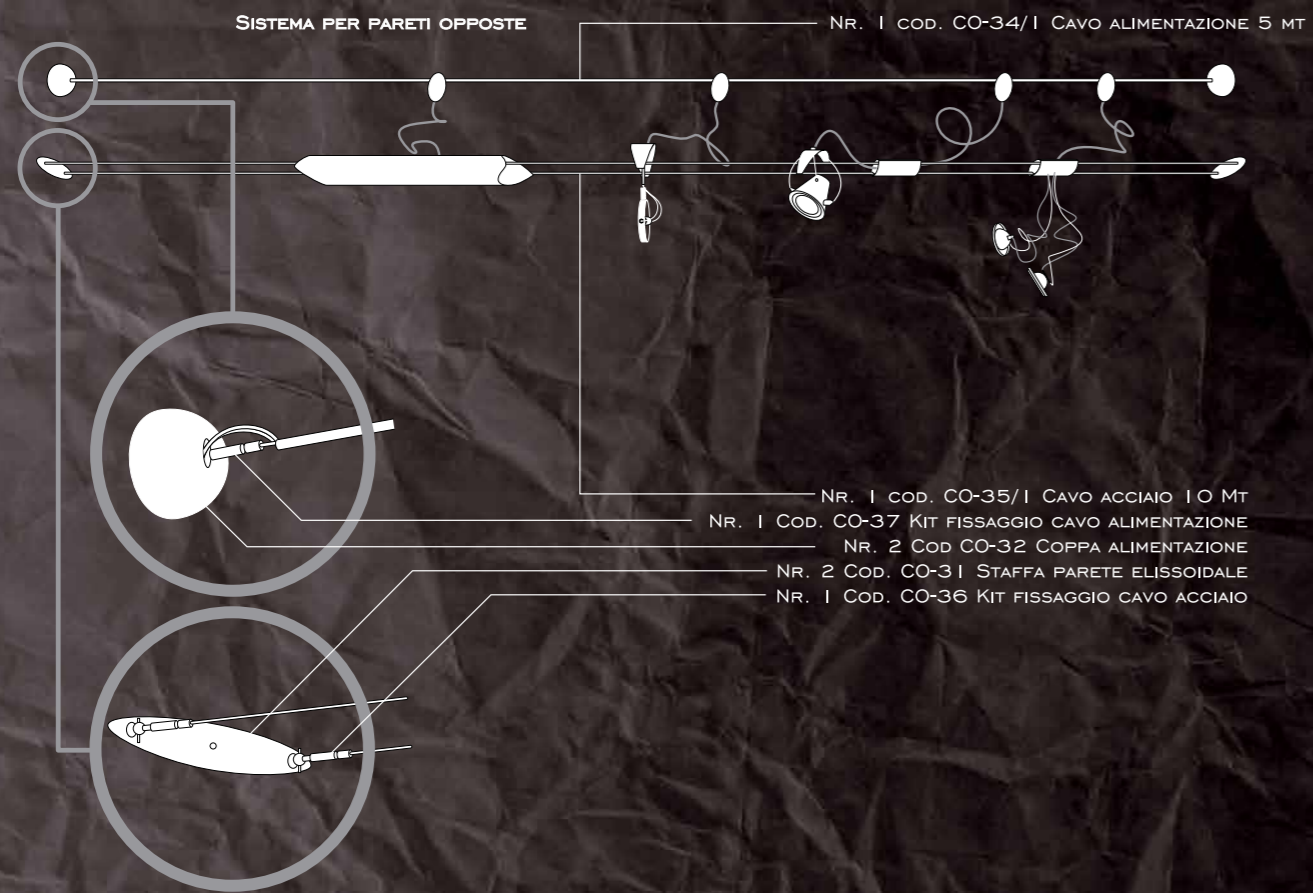

STAFFA PER ANGOLO 90°

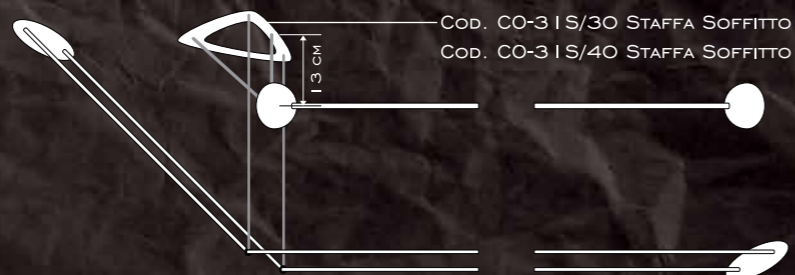
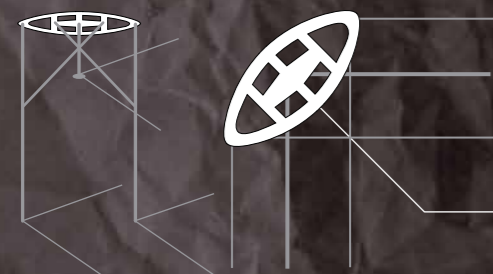

SISTEMA SU UNA PARETE



SISTEMA PER SOFFITTO - PARETE LATERALE



SISTEMA ANGOLO - ANGOLO

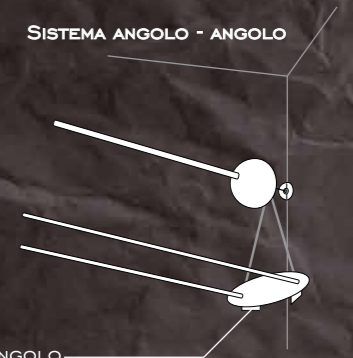

Ho navigato a lungo, trovato quel che cercavo e oggi posso offrire una risposta alle tue e alle mie esigenze: è nato il Sistema Colombo!

Un piccolo ovetto in policarbonato con tre lamelle inserite all'interno, preleva tensione da un cavo teso alimentando un qualsiasi utilizzatore.

Facile e unico.

l' "OVO" di Colombo.

I have travelled far and wide, found what I was searching for and now I am able to provide an answer to all your, and my needs: the COLOMBO SYSTEM is here!

A small polycarbonate egg with three small internal blades, draws power from an electric cable, supplying any type of appliance.

Simple and unique. Like an egg!



Walter Dang - Atelier - Haute Culture



Casa Privata
Private House

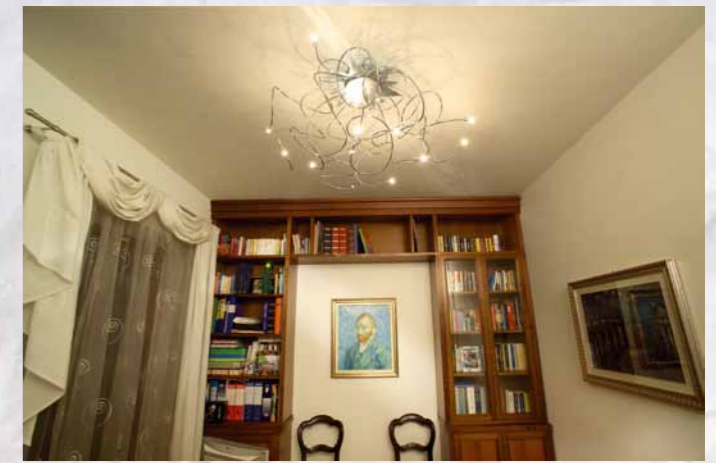

Casa Privata
Private House



Casa Privata
Private House



Villa Tiboldi.



Villa Tiboldi.



Cascina Marcantonio - ACQUI TERME (AL)

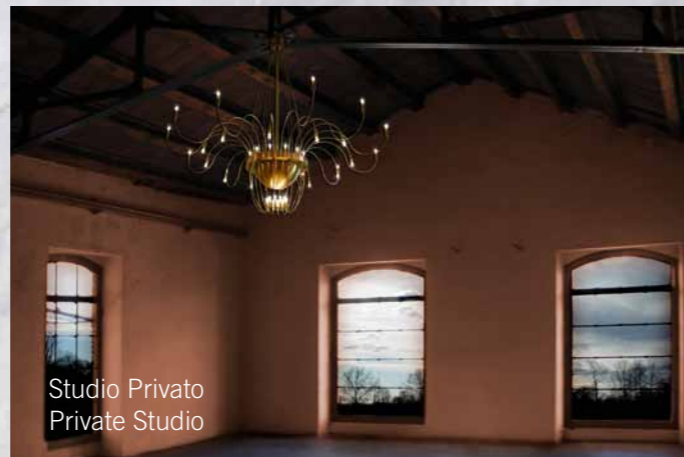

Studio Privato
Private Studio



Locanda del SANTO UFFIZIO - PENANGO (AT)



Cascina Marcantonio - ACQUI TERME (AL)



INVERIGO HOTEL - Gruppo Plinio - INVERIGO (CO)

ART E LIGHT

Riverberata, riflessa, propagata, scandita la luce è sempre accorsa alle richieste dell'arte. Talvolta è la luce a chiedere di lei. Non sempre la trova: l'Arte, si sa, è sempre molto occupata tra Musei e Atelier e sulla bocca di tutti. Ma quando si incontrano la materia si concede nuove vibrazioni e l'effetto è sorprendente.

ART E LIGHT

Reverberated, reflected, propagated, articulated, light has always met art's needs. Sometimes it is light that has need of Art. It doesn't always get it: Art, it is well known, is forever busy between Museums and Atelier and is on everyone's lips. But when they do meet, there are new vibrations and the effect is astonishing.



RED PASSION



SCIVOLI'AMO



LADY ENT



Casa Privata
Private House



I vestiti di Cina.
Cina's dress.



Sala del pensiero (Fabbrica LUCIFERO)
The All of Thought (Lucifero factory)



Casale Monferrato - Museo Civico - Gipsoteca Bistolfi.
Casale Monferrato - Town museum - Bistolfi gallery of plaster casts.



LE VANITÀ DI LUCIFERO
21 - 28 GIUGNO 2006 CHIESA DI SANTA CROCE

Non c'è modestia senza vanità.
(Roberto Gervaso)

Si parla poco quando non è la vanità
a farci parlare.
(François de La Rochefoucauld)

Ci si sbaglierà raramente, attribuendo le
azioni estreme alla vanità, quelle mediocri
all'abitudine e quelle meschine alla paura.
(Nietzsche)

L'adulazione è una moneta falsa
che ha corso solo grazie alla nostra vanità.
(François de la Rochefoucauld)

La Vanità è decisamente il mio peccato preferito.
(Al Pacino "l'Avvocato del Diavolo")

La vanità è alla base di tutto,
anche la coscienza non è altro che vanità interiore.
(Gustave Flaubert)

Ciò che rende la vanità degli altri insopportabile,
è che offende la nostra.
(François De La Rochefoucauld)

LE VANITÀ DI LUCIFERO.

Peccato, tentazione, mistero. Lucifero sa come incantare gli animi con la bellezza e la magia della Luce. E se, come recitò Al Pacino, la vanità è il vostro peccato preferito, allora l'eleganza delle nuove icone non può che esservi tentatrice. Nella chiesa sconsecrata di Santa Croce a Villastellone si sono mostrate in tutto il loro fascino sensuale le regine dell'Oriente, gli scatti per il Catalogo 2007, in anteprima. Geishe, guerriere, donne misteriose quali testimonial di un mondo sconosciuto e ammaliante che vi seguirà tra le creazioni di luce di Lucifero.

Per una volta, non resistete alle vanità.

LUCIFERO VANITY.

Walter Dang - Atelier Couture.

Sin, temptation, mystery. Lucifero knows how to capture the soul with the beauty and magic of Light. And as one of Al Pacino's film characters said: "Vanity is your favourite sin", then the elegance of new icons cannot but tempt you. The deconsecrated church, Santa Croce in Villastellone was host to the Oriental Queens in all their sensual splendour giving a preview of the shots for the 2007 Catalogue. Geishe, warriors, mysterious women all testimonial to an unknown and charming world that will follow you among Lucifero's creations.

For once, succumb to Vanity.





LA FORZA DELLA LUCE

15 - 30 SETTEMBRE 2006
ECOMUSEO SOGNO DI LUCE - ALPIGNANO (TO) - ITALY

LA FORZA DELLA LUCE

Quale luogo migliore per elogiare la luce se non dove la luce ha preso forma? Spieghiamoci meglio: Alessandro Cruto fu l'inventore del filamento di carbonio, piccolo, indispensabile componente della lampadina. L'ecomuseo di Alpignano, costruito sull'allora fabbrica di luce, l'opificio, ospita oggi le testimonianze di una scoperta tanto straordinaria. E Lucifero, con la stessa passione per tutto ciò che è ricerca e sperimentazione ha scelto questa suggestiva location per presentare le sue creazioni. Immagini impattanti a simboleggiare l'energia luminosa creata dal maestro della luce attraverso le sue opere d'arte. Non tutti possono avere in dono la forza della luce, ma con Lucifero, il virtuosismo scintillante della creatività vi avvolgerà in un turbinio di emozioni.

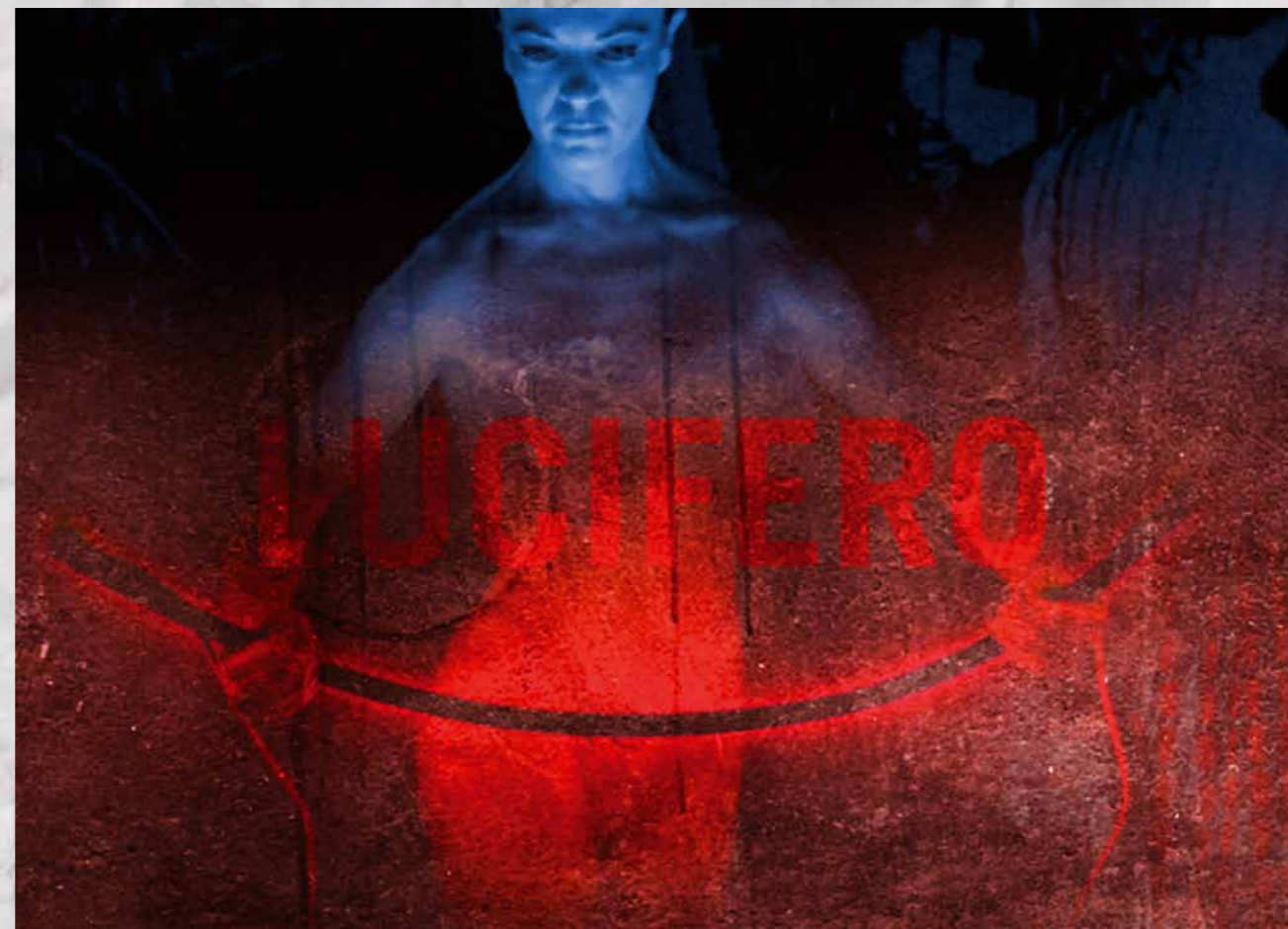

THE POWER OF LIGHT

15 - 30 SETTEMBRE 2006
ECOMUSEO SOGNO DI LUCE - ALPIGNANO (TO) - ITALY

THE POWER OF LIGHT

What better place to praise light than where it was created? To better explain: Alessandro Cruto was the inventor of the carbon filament, the small but indispensable part of a light bulb. The Eco-Museum in Alpignano, which is built on the site of the "Light Factory" now holds the evidence of that extraordinary discovery. Lucifero, with the same passion for all things concerning research and experimentation, chose this atmospheric location to present its creations to the general public. Astonishing images used to symbolize the luminous energy created by the master of light through his works of art. The talent of the Power of Light is not given to everyone, but with Lucifero, its sparkling creativity will pick you up in a whirlwind of emotions.



Video LA FORZA D DELLA LUCE



LUCIFERO: PARATISSIMA 2008 - I PRODOTTIVORI

I prodottivori

Da una parte le insicurezze dell'uomo moderno, alla continua ricerca di conferme. Dall'altra la pubblicità: accattivante, coinvolgente... falsa.

Ed ecco che i prodotti materiali diventano un sogno di fuga e benessere: comprare, buttare, ricomprare. Acquistare più di quanto serve. Fagocitare tutto ciò che è disponibile, il vortice del consumismo irrompe nella quotidianità rendendo il mondo saturo di oggetti, spesso superflui.

Gli essere umani paiono ciechi di fronte alla piaga del consumo senza freni: maschera sugli occhi e ghiaccio nel cuore. Sono i "prodottivori", i nuovi cannibali dell'era contemporanea: un neologismo per un fenomeno certo non nuovo e che sta accompagnando la Terra alla catastrofe.

Ma noi vogliamo credere che la luce della mente potrà ancora illuminare la nostra vita.

The "Prodottivori"

From one side there are insecurities of modern people who are constantly in search for confirmation. From the other side, there is advertising: charming, attractive... and false.

The material products are becoming a dream, a dream for escape and well-being: to buy, to waste and to buy again. To buy more than we need. To phagocytize everything that is available is possible, now. Irresponsible consumption is coming brutally into our everyday's life and our everyday's life is full with things, often superfluous.

Human beings seem to be blind in front of the curse of consumption with no restrictions. One mask on the eye and ice inside the heart. We call them "prodottivori", the cannibals of modern times: a neologism for a phenomenon which is not new and it is going to lead the earth toward a catastrophe.

Yet, we want to believe that the light inside our mind can still bring light into our life.



Sabater Hermanos
Soap Shop



Negozio Giocattoli Educativi
Educational Toys Shop

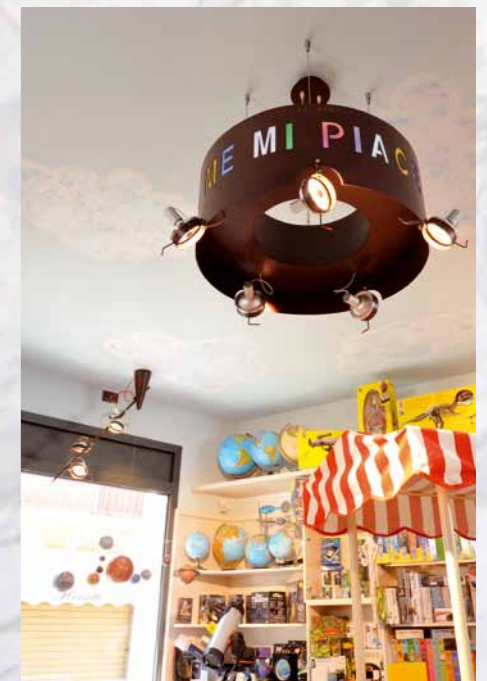



La Luce Degli Angeli:

Origami di luce, origami di carta si trasformano in avvolgenti vesti per impreziosire i nostri angeli. Sono gli Angeli Luciferini , tra arte e nuvole, nuvole e arte.

Sullo sfondo il cielo, tra i capelli suggestioni arcaiche che rimandano ad atmosfere oniriche: Raffaello, il Botticelli, sono i grandi del passato a far da testimoni con aulica pittura.

Volate leggeri nell'aria vibrante, volate in mezzo a noi.

Con energia infinita, ci osservano, ci assistono, ci supportano nel nostro cammino verso la conoscenza: gli angeli. Risplende Lucifero in mezzo a loro, sommo maestro portatore di luce, tra peccato, virtù e vanità.

"I nostri occhi non vedono, ma apriamo il cuore all'intelletto. Così scopriremo la luce".

Lucifero e la luce, Lucifero e i suoi corpi luminosi. Giorno, notte, alba o tramonto, è l'arte di Lucifero a farsi spazio tra le nuvole e ad accompagnare i momenti della vita. Con angelica ironia: nove creazioni di illuminata poesia, nove angeli protagonisti dell'inesauribile iridescenza "luciferina".

The light of Angels

Origami of light and paper transform into delicate clothes which splendour our angels. They are Lucifer's disciples, between art and clouds, clouds and art. On a backdrop of sky, ancient emotions in the angel hair bring to mind a dream like atmosphere: Raffaello, Botticelli, the grand masters of the past who gave testimony their fine works of art.

"Fly gently in the vibrant air, fly among us".

With endless energy, they watch us, they aid us, they guide us on our way towards knowledge: The angels. Lucifer is the brightest among them, the supreme master, the carrier of light, between sin, virtue and vanity.

"Our eyes cannot see, but let us open our hearts to intellect. That way we can find the light".

Lucifer and the light, Lucifer and his luminous bodies. Day, night, sunrise or sunset, it is Lucifer's art which makes space among the clouds and accompanies life's events. Created with angelic irony: nine creations of enlightened poetry, nine angels which are centre players in the endless "Lucifero" iridescence.



LUCE DIVINA - 2008 - ASSOCIAZIONE BONZANIGO - ASTI (TO) - ITALY



Video Luce Divina



LA NOTTE NERA

VENERDÌ 17 SETTEMBRE 2010 - ORE 24:00

Lucifero rende omaggio alle sue creazioni luminose organizzando un'Evento unico nel suo genere: "La Notte Nera".

Guidati dall'Angelo Oscuro, portatore di Luce sarete accompagnati nel suo Regno oltrepassando quella sottile linea che divide la Notte più Nera dal sorgere del nuovo Giorno, d'altronde: "Per arrivare all'alba non c'è altra via che la notte" citando le parole del Filosofo e Poeta Libanese, Kahlil Gibran.



Video La Notte Nera





Casa Privata
Private House



Casa Privata
Private House

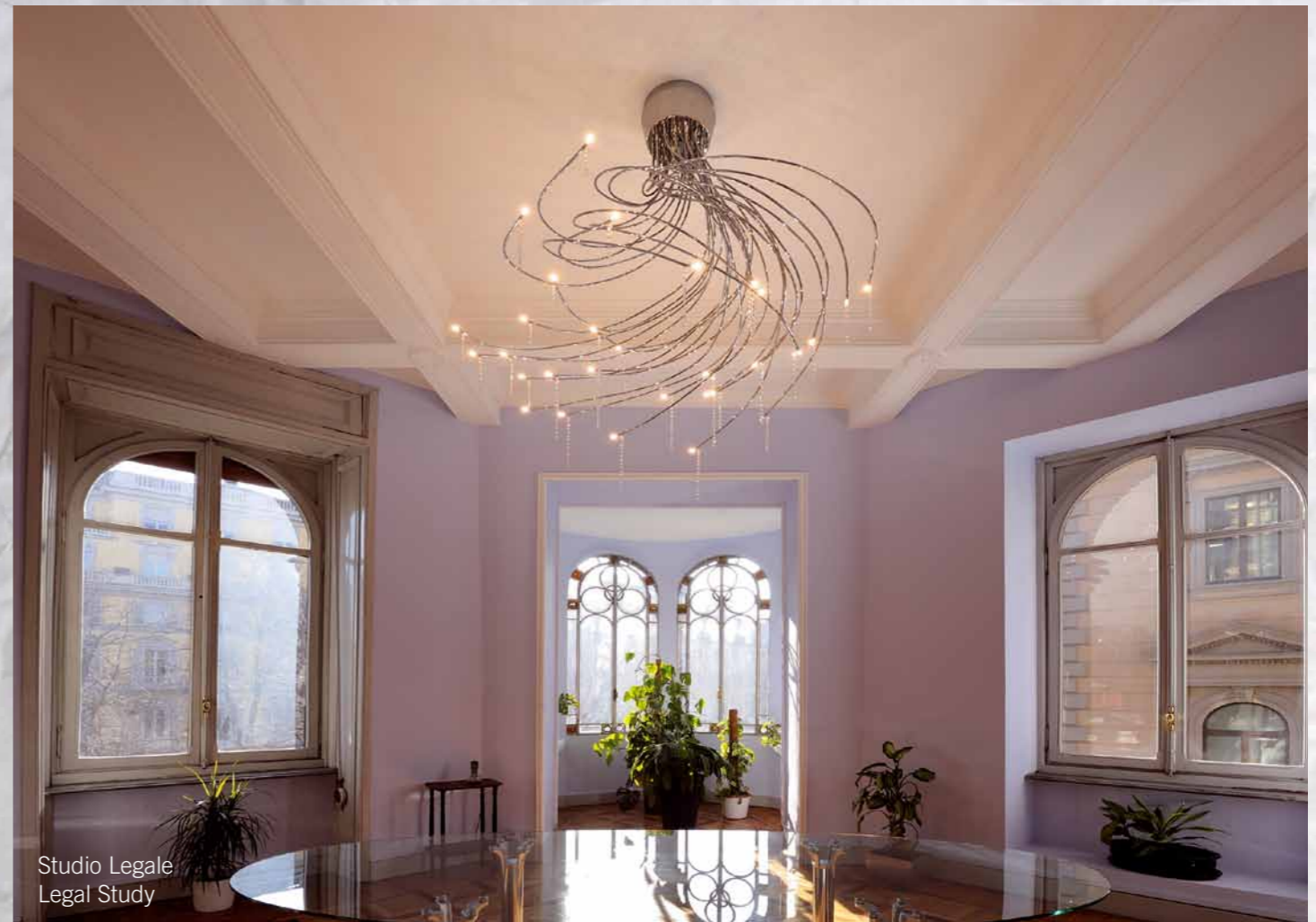

Studio Legale
Legal Study



Casa Privata
Private House



Casa Privata
Private House

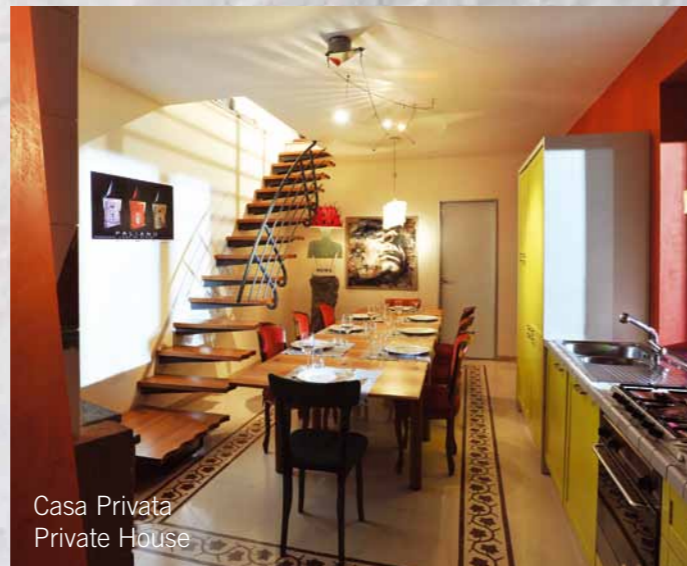

Casa Privata
Private House

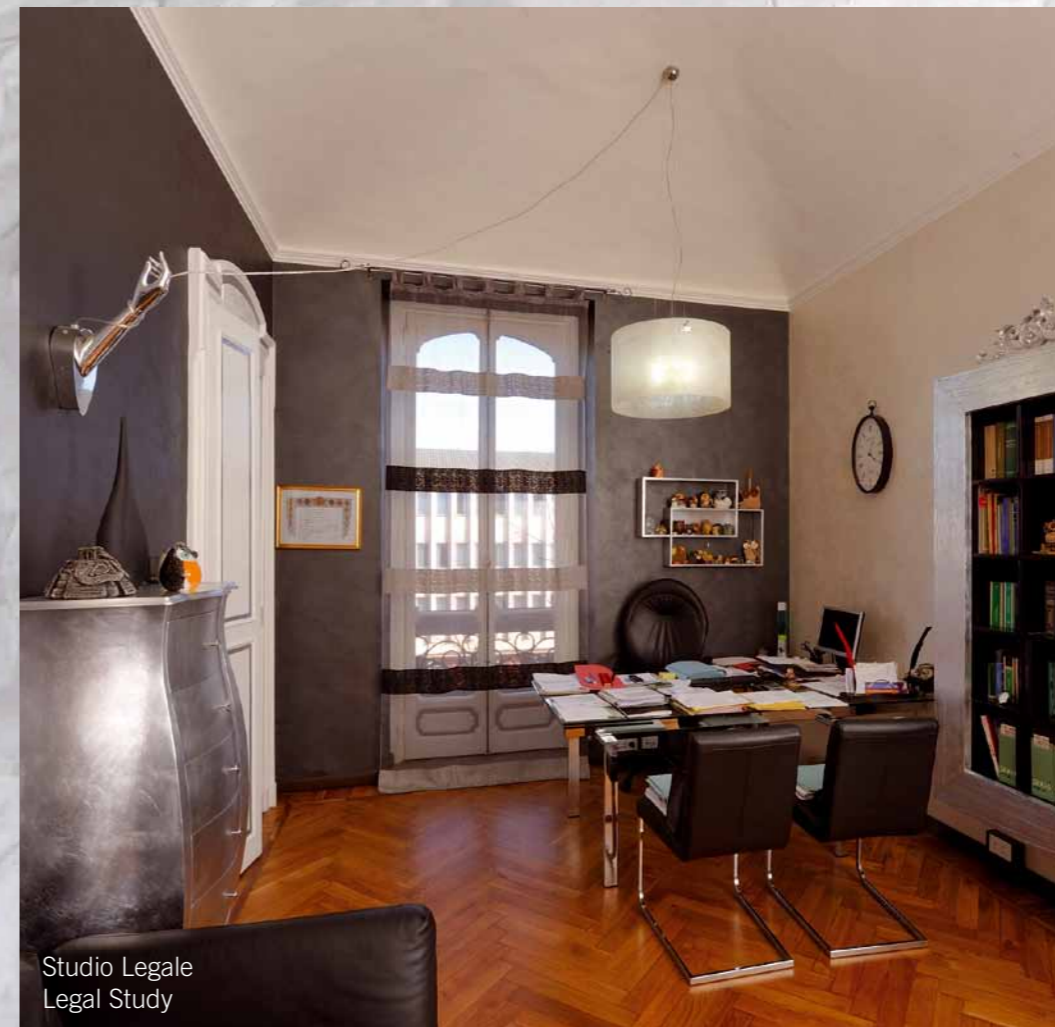

Studio Legale
Legal Study



Studio Legale
Legal Study

15 - 24 Marzo 2011
IL MITO DI ECATE - LUCE NERA

"Ecate... amabile, celeste e terrestre e marina, dal manto color croco...".

Ecate dea delle tenebre e della luce, sospesa tra cielo e terra, tra mascolino e femminile, celestiale ed infernale al tempo stesso. Orribile e seducente, come solo la notte può essere.

Luce Nera appunto, come "complexio oppositorum" dove gli opposti convivono in un equilibrio perfetto, in cui la luce svelata rischiara le tenebre e l'anima libera il corpo.

Le installazioni luminose interagiscono con lo spazio e con i corpi dei danzatori per mettere in scena le seduzioni del buio e del suo opposto.

Lavanderia a Vapore - COLLEGNO (TO)



Video Il Mito di Ecate



PROGETTO: LUCIFERO
FOTOGRAFIA: IMMAGINARIO
MENEGATTI & MANFREDI
COSTUMI: WALTERDANG
MAKE-UP: GLORIA CORTIGIANI
PROGETTO GRAFICO: MALART
LUCA MARIETTA A.

PLAN: LUCIFERO
PHOTOGRAPHIC: IMMAGINARIO
MENEGATTI & MANFREDI
COSTUMI: WALTER DANG
MAKE-UP: GLORIA CORTIGIANI
GRAPHIC PROJECT: MALART
LUCA MARIETTA A.



LUCIFERO[®]
ILLUMINAZIONE

LUCIFERO ILLUMINAZIONE S.R.L.

VIA MOLINI 35 - 10098 RIVOLI - TORINO - ITALY
TEL. ++39 011.959.84.33 - FAX ++39 011.957.49.61
HTTP://WWW.LUCIFEROILLUMINAZIONE.COM
E-MAIL: LUCIFERO@LUCIFEROILLUMINAZIONE.COM